

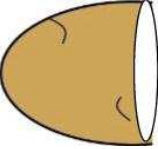
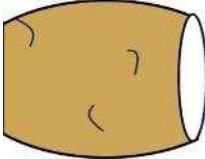
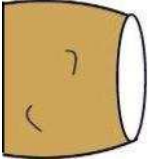
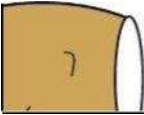
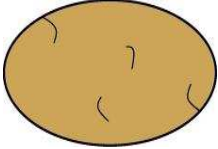

395 West Hwy 39, Blackfoot, ID 83221  
**Phone** 208.785.4285    **Toll Free** 800.574.1852  
**Fax** 208.785.1060  
info@milestone-equipment.com  
www.Milestone-Equipment.com

## SEED PIECE PROFILE TABLE

1 Cut Top or Bottom Table	2" Barrel Cut Bottom Table	1 3/4" Barrel Cut Top Table	Horizontal Vertical Cut	One Drop
 A potato cut in half lengthwise, showing a flat white surface on one side.	 A potato cut into a thick, flat slice, showing a white surface on one side.	 A potato cut into a thick, flat slice, showing a white surface on one side.	 A potato cut into a thick, flat slice, showing a white surface on one side.	 A whole potato with a slight indentation at the top, showing a white surface on one side.

**LEADERS IN CUSTOM MANUFACTURED POTATO HANDLING EQUIPMENT**  
**SEED CUTTERS \* SEED TREATERS \* DIRT ELIMINATORS \* PILERS \* CONVEYORS \* ACCUSIZERS**

# CUTTER SET UP AND START UP PROCEDURES

**\*\*IMPORTANT\*\***

***CUTTER ADJUSTMENT PROCEDURES MUST BE COMPLETED FIRST  
(ALL 7 STEPS)***

## SETTING UP CUTTER

1. Position Cutter - Confirm the following:
  - ***Make sure all guards are in place***
  - The cutter is level from side to side.
  - Inspection table is accessible on both sides of machine
  - Everything is free from rubbing on the belts
  - Position duster (remember duster turns counter clockwise, therefore the duster must be a little off center, towards opposite side of duster control.)
2. Ensure the coulter blades are the same distance from the back upright angle.
3. Switch on power disconnect on cutter, but do not turn the cutter on.
  - Confirm that all three lights (yellow, green and red) are lit up on the electric eye. *If not, check and see if all the E-stops are pulled out (1 on power box and 2 up by top of hopper. and Confirm that the coulter kill switch is attached)*

### Electric Eye

Yellow---power to eye

Green----has small amount reflection.

Red-----has excess amount of reflection.

*If there is a green light but no red, wipe off the reflector and twist the electric eye until red appears. You can aim it by seeing red in the reflector.*

4. Make sure machine is running in the right direction by switching on power supply only to hopper/conveyors. If not running the right direction, switch line 1 and line 3 (3 phase only) in electrical disconnect on side of electrical panel. Slow down elevator and close top sizer half way and bottom sizer most of the way, and pre-sizer all the way.

***NOW YOU'RE READY TO RUN***

## 5. MAKE SURE NOONE IS IN THE MACHINE

Switch on power to the entire cutter

- Buzzer should sound.
- Make sure the machine is running smoothly.
- Slowly add potatoes to machine. For now, keep elevator running slow.
- Adjust top sizer to where 7 oz. potatoes are on top and 6 oz. potatoes are on the bottom.

6. Adjust the bottom sizer, drop out those potatoes which you would not like to cut in half.
7. Check the cross cut knife and make sure you are cutting the potatoes in the middle. To do this:
  - Catch a top and bottom of the same potato and determine if they are both even.
  - Adjust by raising or lowering each side.
  - Be patient and take your time. ***This is Important!***
8. Go to the back of cutter and take a sample. **Refer to sample taking.**
  - Let your sample determine what adjustments need to be made.
  - Adjust cutter according to sample taking instructions.
  - Make sure those on the inspection table, cutting by hand are educated in what their jobs are. They can change a sample if not
9. Check the trim rollers and see what waste you are creating. You can make adjustments to control the waste by following steps 5-8.
  - If the pieces being cut by the cross cut knife are falling through the trim rollers, make sure you are cutting in the middle and not cutting them too small.
  - If continuing with too much waste, shut down machine and move trim rollers 1/16" closer or speed up trim rollers.
10. Open the pre-sizer a little bit at a time until desired size is being eliminated.
11. After making all necessary adjustments,
  - Adjust the elevator speed and increase capacity until you the desired rate. *Remember, if you over crowd the table, your quality goes down.* You must give room for the potatoes to turn before they come to the coulter blades.
  - Make necessary adjustment to accommodate the speed.
12. Confirm duster is putting on enough dust.
  - If dust is coming out of the corner of the discharge chute, slow down the dust.
  - If not enough, adjust the dust faster.

***ALWAYS TAKE SAMPLES TO MAKE NECESSARY ADJUSTMENTS***

# MILESTONE CUTTER ADJUSTMENT PROCEDURES

- **STEP 1** Check bolt on end of coultter shafts (top & bottom) for tightness. Then remove drive so drums turn freely.
- **SETP 2** Line up center of progressive roller pipe shaft with coultter shaft. Raise or lower coultter to  $\frac{1}{4}$ " (top) gap and  $\frac{1}{8}$ " (bottom) gap. Make sure outside coultter blade is same height as rest of coultter blades. CAUTION – Lowering coultter blades too low may cause blades to cut progressive rollers.
- **STEP 3** Adjust strippers to  $\frac{3}{8}$ " between stripper end and coultter spacers.

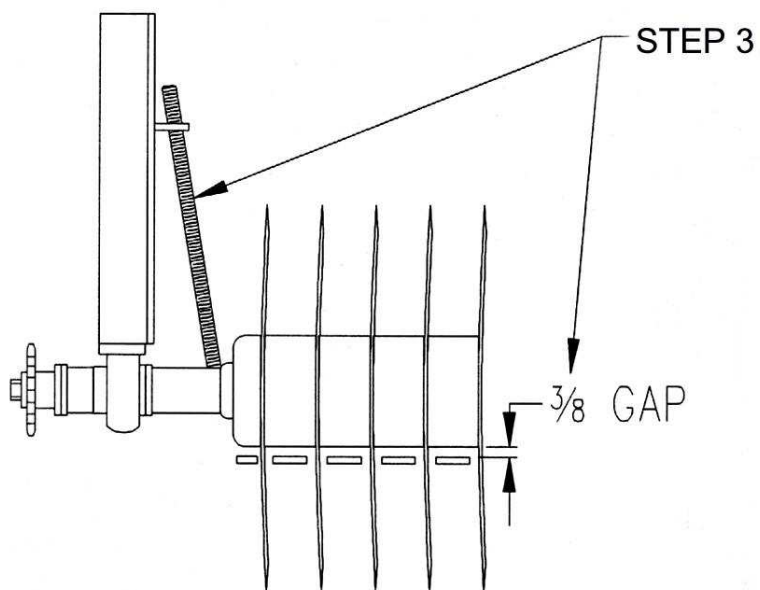
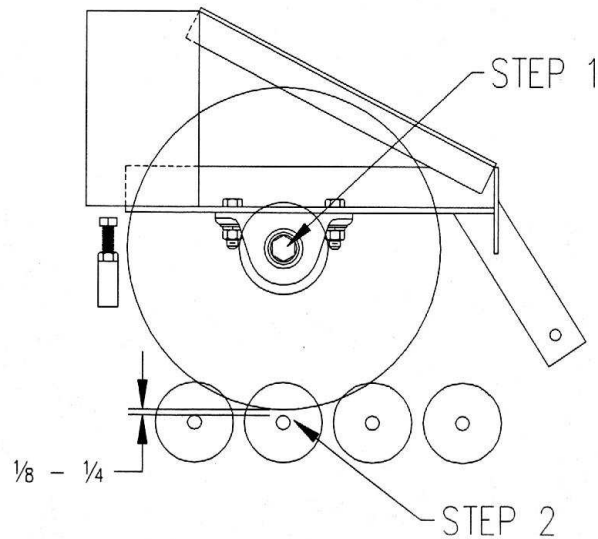

## MILESTONE CUTTER ADJUSTMENT PROCEDURES

- **STEP 4** Lower top drum down on each side until a faint ticking is heard by rotating drum towards hopper. Adjust both sides accordingly, and it is good to double check.

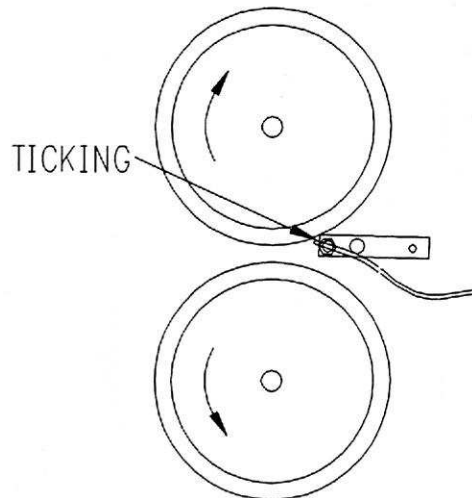
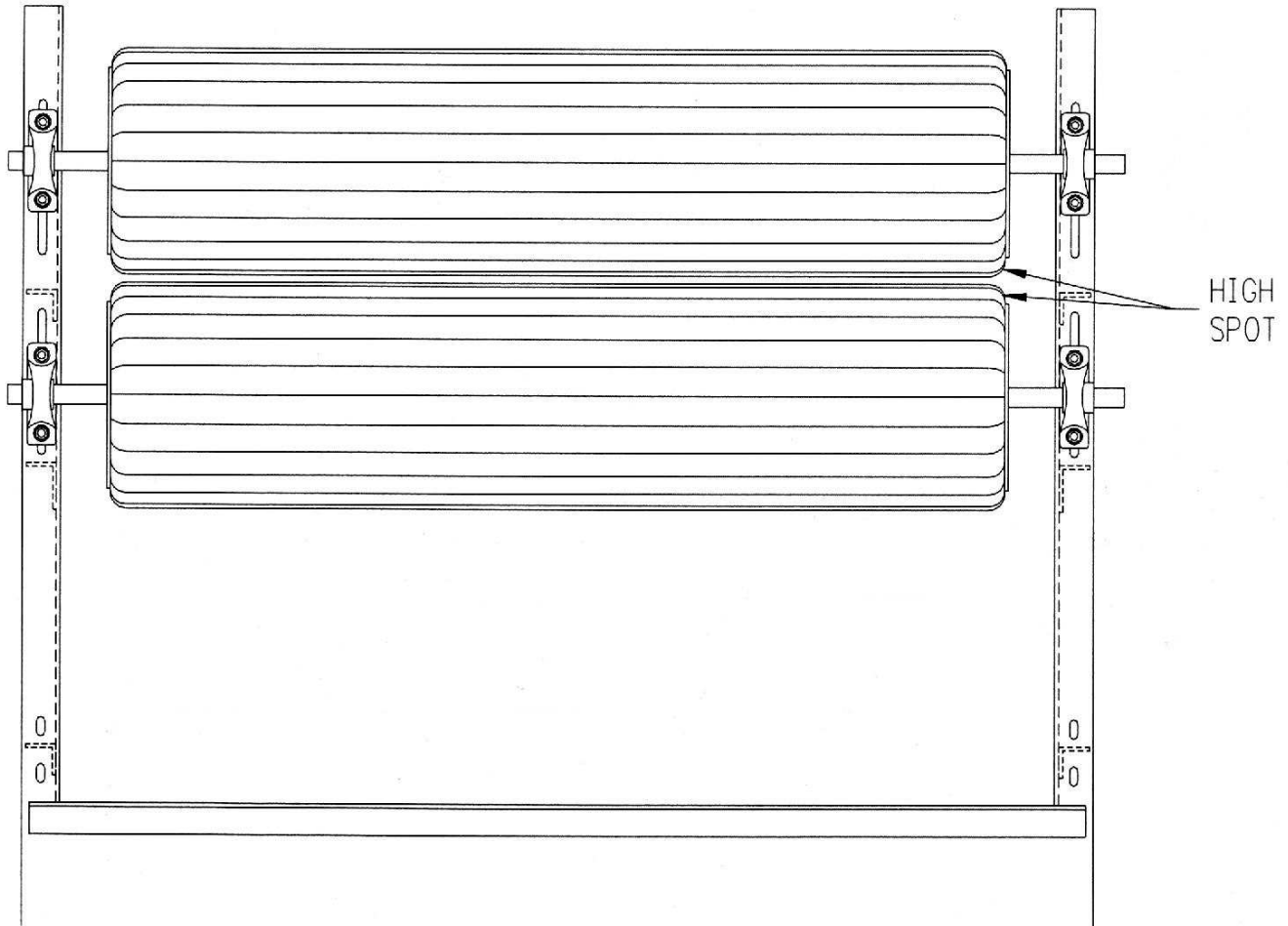

# MILESTONE CUTTER ADJUSTMENT PROCEDURES

- **STEP 5** Find high spot on bottom drum and turn it to 1 o'clock position. Drop a measuring tape down through strippers to high spot on drum. Raise or lower drum to 1-1/2" from bottom of stripper to high spot on drum.
- **STEP 6** Find high spot on top drum. Turn high spot on top drum to 6 o'clock and high spot on bottom drum to 12 o'clock. So the high spots on each drum face each other. Put drive chain on while drums are in this position.
- **STEP 7** Center cross cut know evenly between both drums.

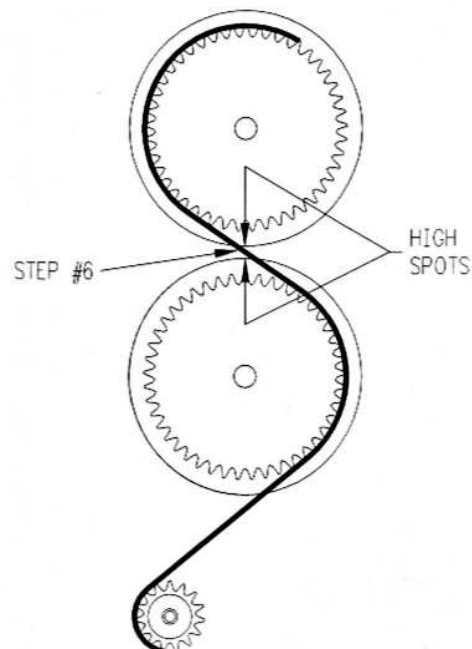
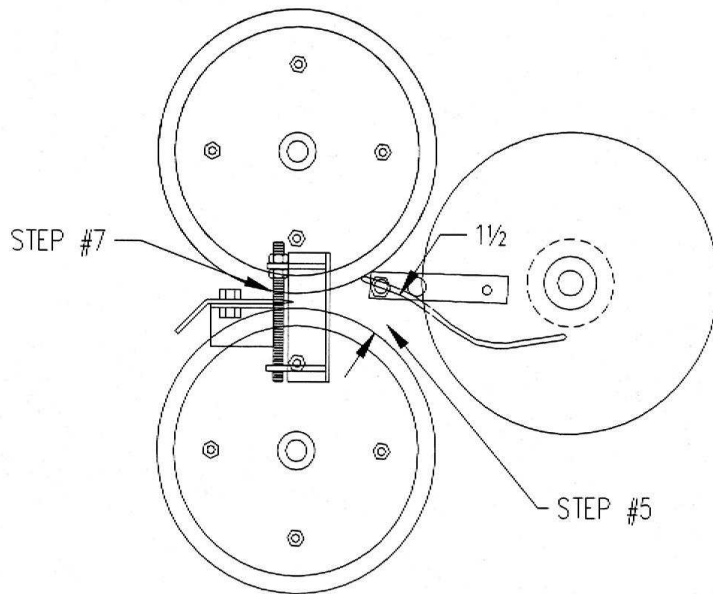

# SAMPLE TAKING

## Lay samples out on mat

- Place samples on mat in their respective categories.

## MAKING ADJUSTMENTS

**Whole Seed** - If the whole seed is too big

- Close down bottom sizer and pre-sizer. Ideally, close pre-sizer up completely, and then adjust bottom sizer.
- After bottom sizer is set, adjust pre-sizer.

**1 CUT** - These are usually end pieces from the top table.

- If these are small potatoes cut in half, and are too small, open bottom sizer.
- If these are bigger potatoes and are too small, open top sizer.
- If they are bigger potatoes which weigh heavy, close top sizer.

**2 CUT 1 3/4" (Barrel cuts)** - These are all being cut on the top table.

- If these are too small, open the top sizer.
- If these are too big, move the coulter blades towards the discharge 1/8" at a time. Make sure to move both sides the same. The closer the blades are to the sponge drums allows the smaller diameter potatoes are pulled through the horizontal blade.

**2 CUT 2" (Barrel cuts)** - These are all being cut on the bottom table.

- If these are too big, close top sizer.
- If these are too small, open bottom sizer.

**3 CUT OR HORIZONTAL CUTS** - These are all being cut on the top table and being pulled up by the sponge drums through the cross cut knife.

- If these are too small, confirm they are being cut in the middle, and then move the coulter blades towards the inlet end 1/8" at a time, both sides.

❖ ***Samples should be taken before and after adjustments.***

❖ ***You cannot adjust cutter for one potato. Take any average.***





❖ ***Educate the people that are responsible for both operating and hand cutting on inspection table.***

❖ ***You can control the waste by making the necessary adjustments with the sizers.***

❖ ***The bigger the seed, the bigger the average.***

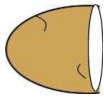
## SEED PIECE PROFILE - ADJUSTMENT TABLE

Adjust cutter accordingly as to where your cut seed fits into the table.  
 If cutter does not respond, set drums. See Cutter adjustment procedures.

Actual Weight	1 Cut Top or Bottom Table	2" Barrel Cut Bottom Table	1 3/4" Barrel Cut Top Table	Horizontal Vertical Cut	One Drop
					
<b>1.4 oz. &amp; under</b>	Open Bottom Sizer	Open Bottom Sizer	Open Top Sizer	Move Coulters away from Drums	NONE
<b>1.5-2.9 oz.</b>	NONE	NONE	NONE	NONE	NONE
<b>3-4 oz.</b>	NONE	NONE	NONE	NONE	NONE
<b>4.1 oz. &amp; over</b>	Close Bottom Sizer	Close Top Sizer	Move Coulters Towards Drum	Tubers are too Large	Close Pre-Sizer or Bottom Sizer





## SEED PIECE PROFILE TABLE



NAME \_\_\_\_\_

DATE \_\_\_\_\_

VARIETY \_\_\_\_\_

TIME \_\_\_\_\_

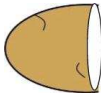
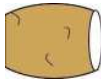
PULP TEMPERATURE \_\_\_\_\_

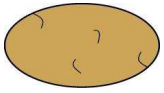
Actual Weight	1 Cut Top or Bottom Table	2" Barrel Cut Bottom Table	1 3/4" Barrel Cut Top Table	Horizontal Vertical Cut	One Drop
					
1.4 oz. & under					
1.5-2.9 oz.					
3-4 oz.					
4.1 oz. & over					

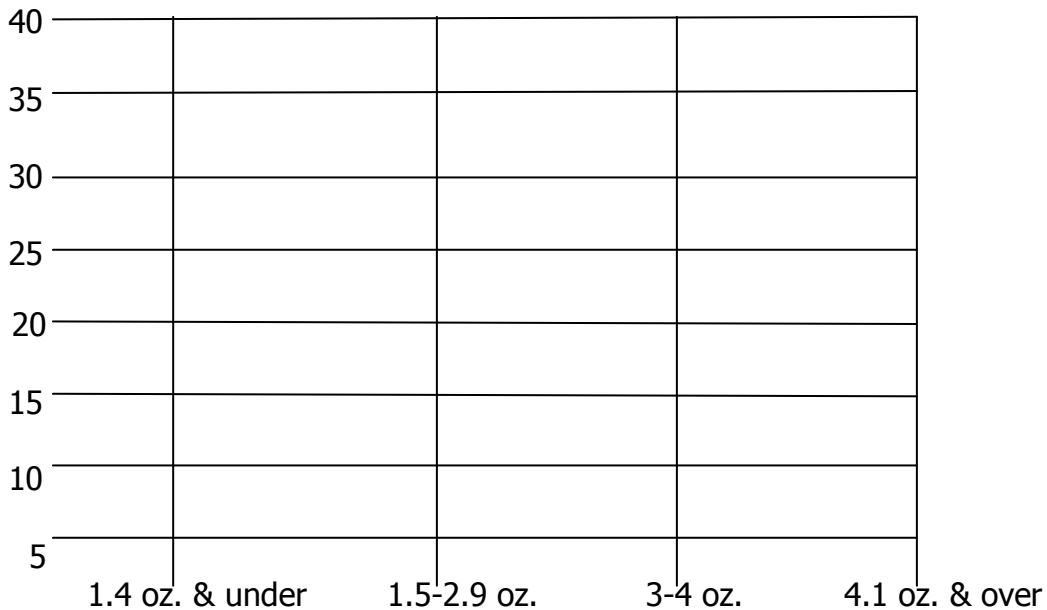

**N**

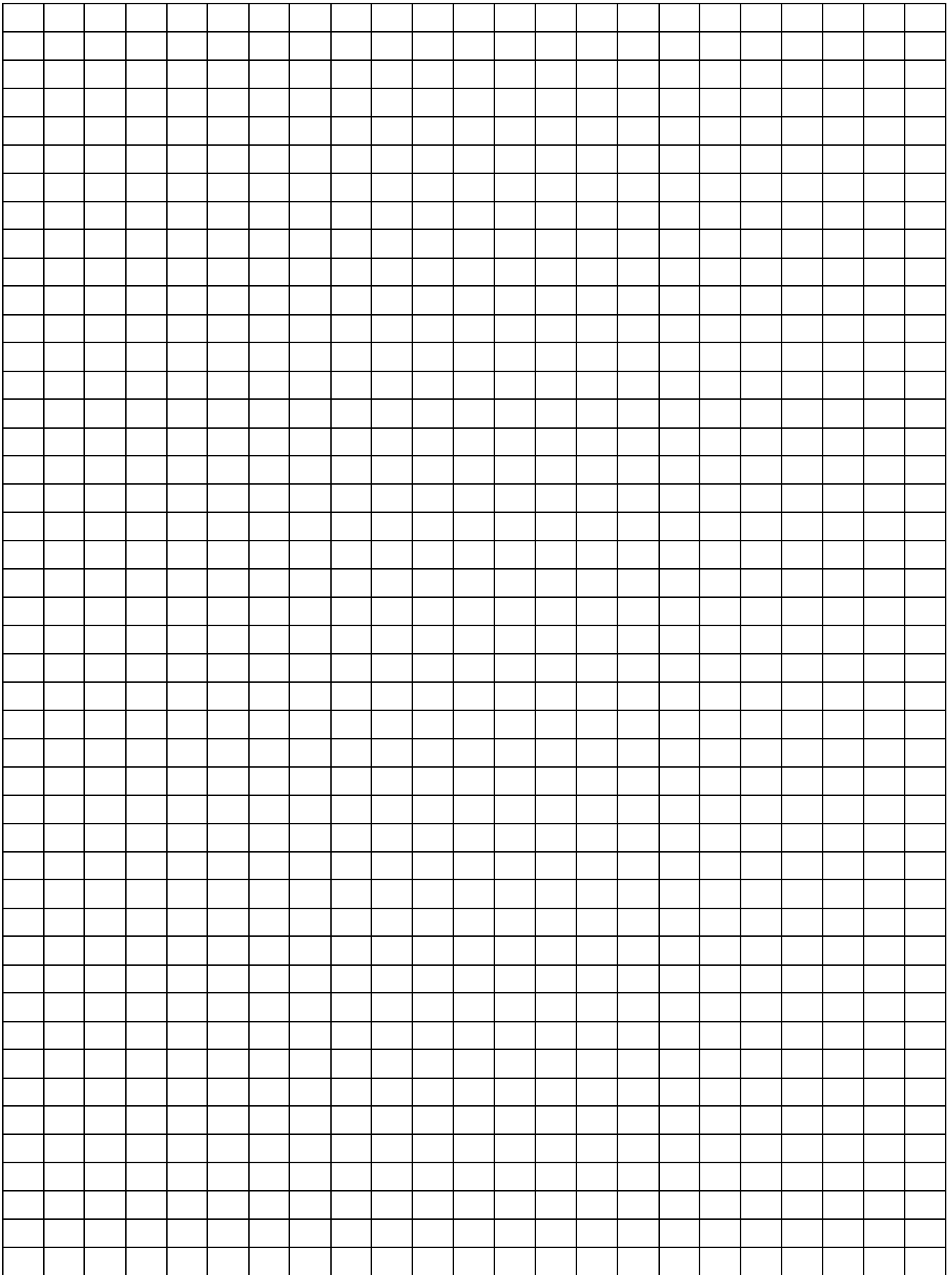

**W**

**E**

**S**



## SEED PIECE PROFILE TABLE



NAME \_\_\_\_\_

DATE \_\_\_\_\_

VARIETY \_\_\_\_\_

TIME \_\_\_\_\_

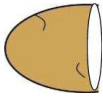
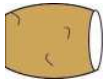
PULP TEMPERATURE \_\_\_\_\_

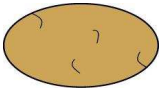
Actual Weight	1 Cut Top or Bottom Table	2" Barrel Cut Bottom Table	1 3/4" Barrel Cut Top Table	Horizontal Vertical Cut	One Drop
					
<b>1.4 oz. &amp; under</b>					
<b>1.5-2.9 oz.</b>					
<b>3-4 oz.</b>					
<b>4.1 oz. &amp; over</b>					

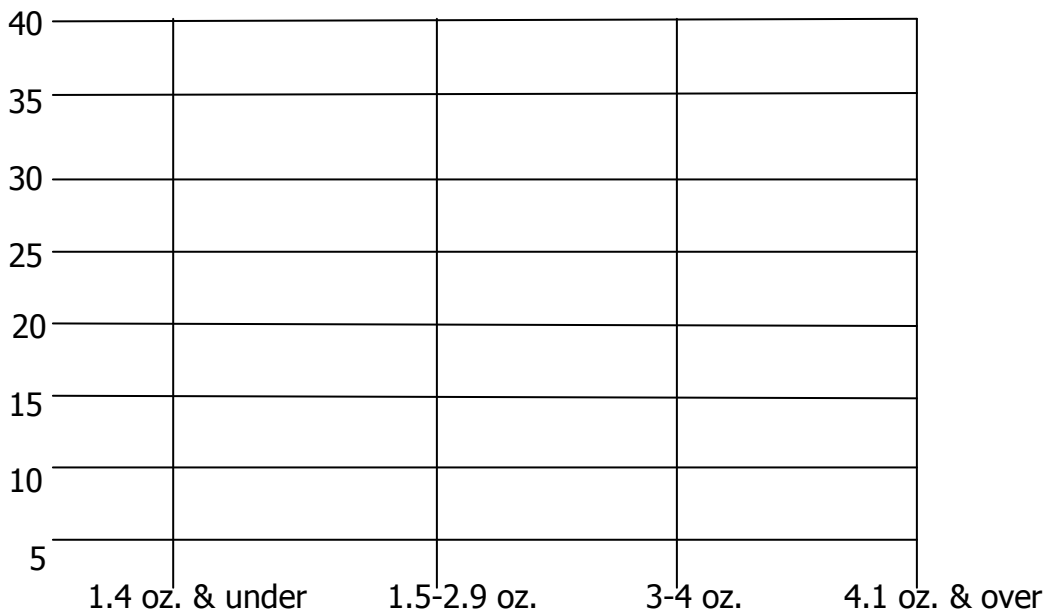

**N**

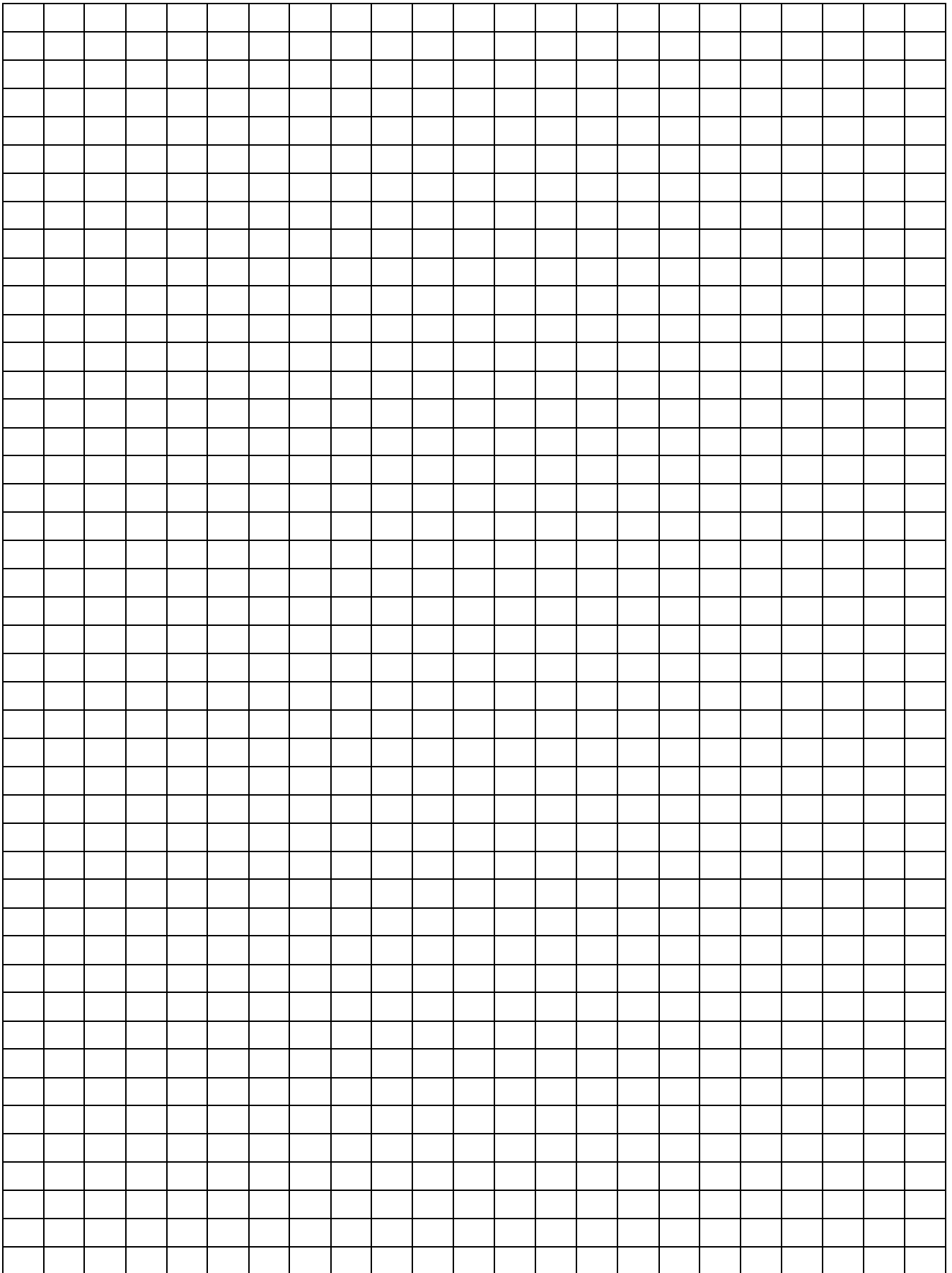

**W**

**E**

**S**



## SEED PIECE PROFILE TABLE



NAME \_\_\_\_\_

DATE \_\_\_\_\_

VARIETY \_\_\_\_\_

TIME \_\_\_\_\_

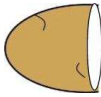
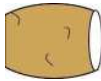
PULP TEMPERATURE \_\_\_\_\_

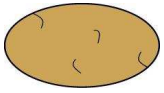
Actual Weight	1 Cut Top or Bottom Table	2" Barrel Cut Bottom Table	1 3/4" Barrel Cut Top Table	Horizontal Vertical Cut	One Drop
					
<b>1.4 oz. &amp; under</b>					
<b>1.5-2.9 oz.</b>					
<b>3-4 oz.</b>					
<b>4.1 oz. &amp; over</b>					

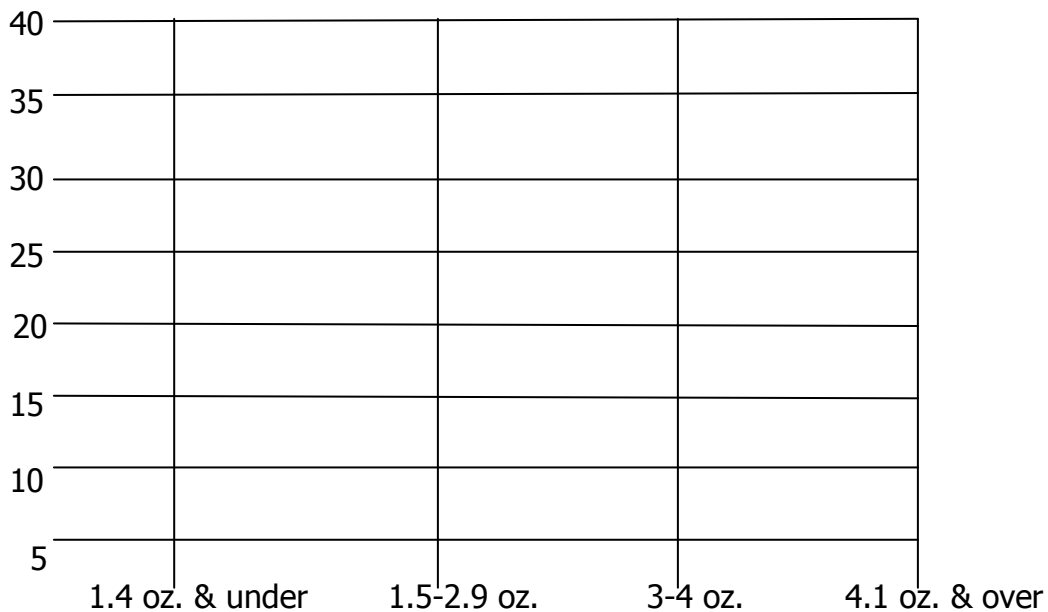

**N**

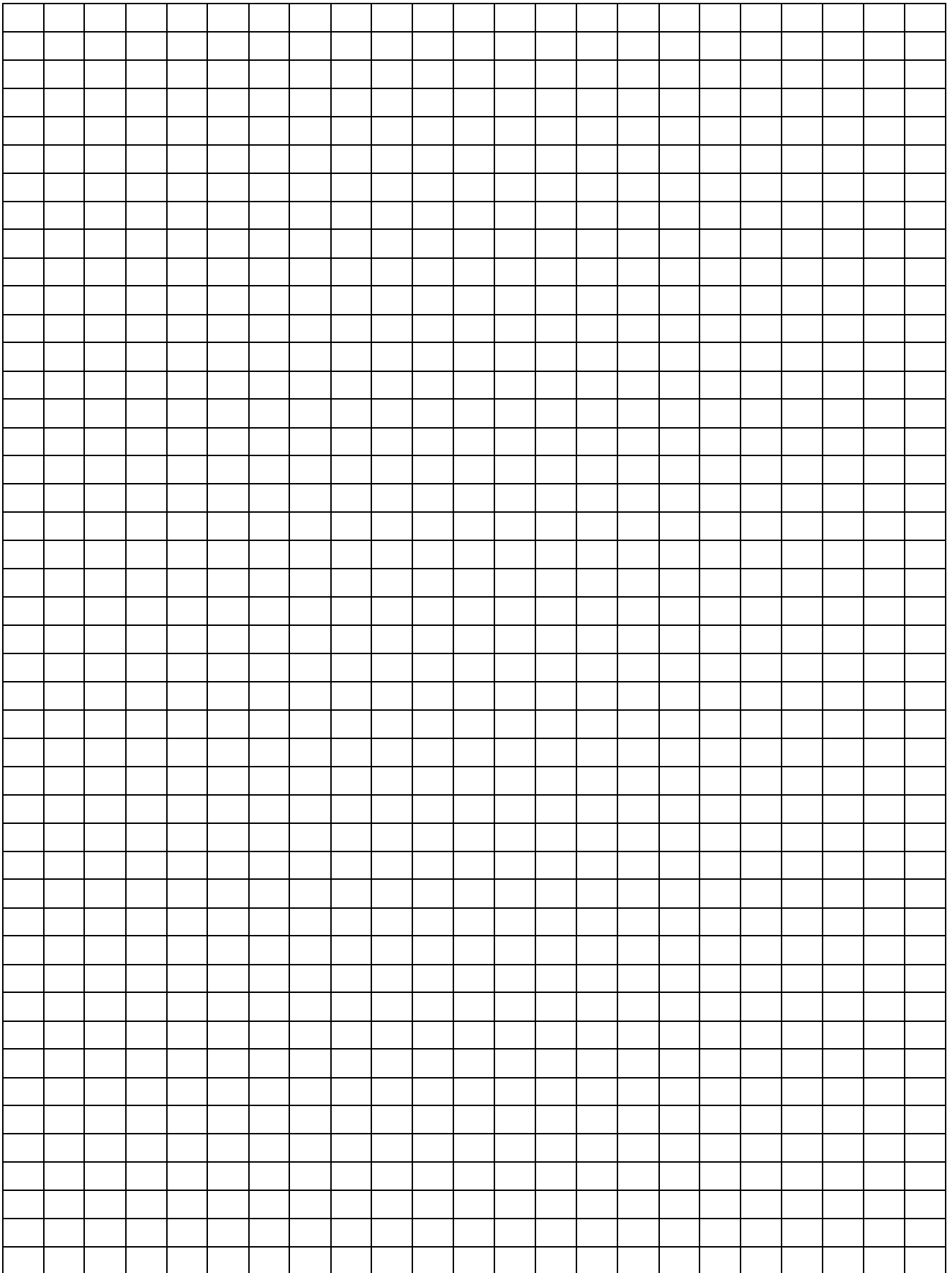

**W**

**E**

**S**



## SEED PIECE PROFILE TABLE



NAME \_\_\_\_\_

DATE \_\_\_\_\_

VARIETY \_\_\_\_\_

TIME \_\_\_\_\_

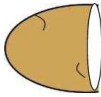
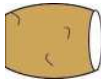
PULP TEMPERATURE \_\_\_\_\_

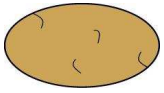
Actual Weight	1 Cut Top or Bottom Table	2" Barrel Cut Bottom Table	1 3/4" Barrel Cut Top Table	Horizontal Vertical Cut	One Drop
					
<b>1.4 oz. &amp; under</b>					
<b>1.5-2.9 oz.</b>					
<b>3-4 oz.</b>					
<b>4.1 oz. &amp; over</b>					

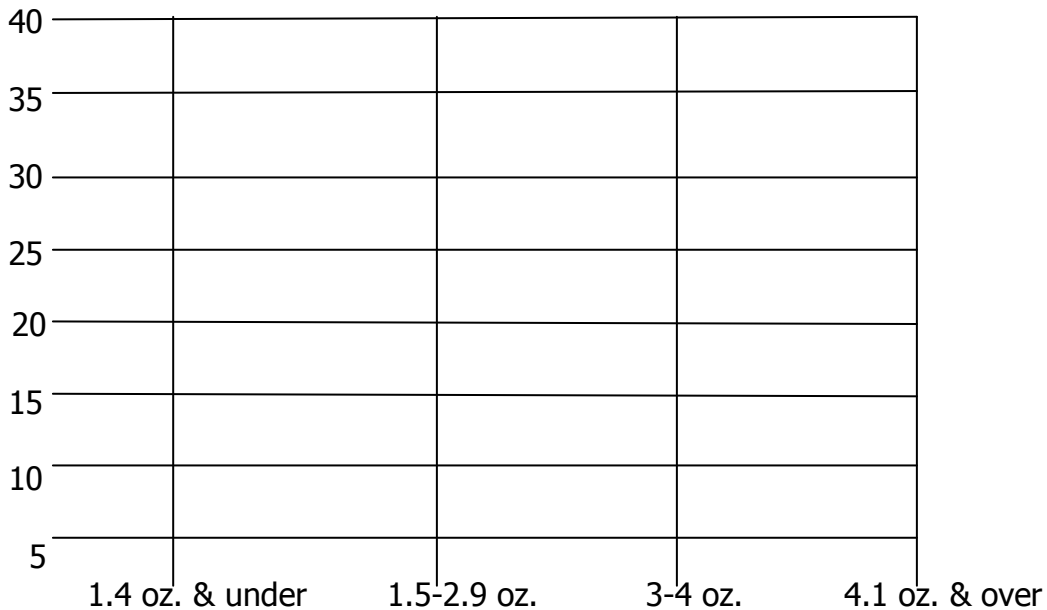

**N**

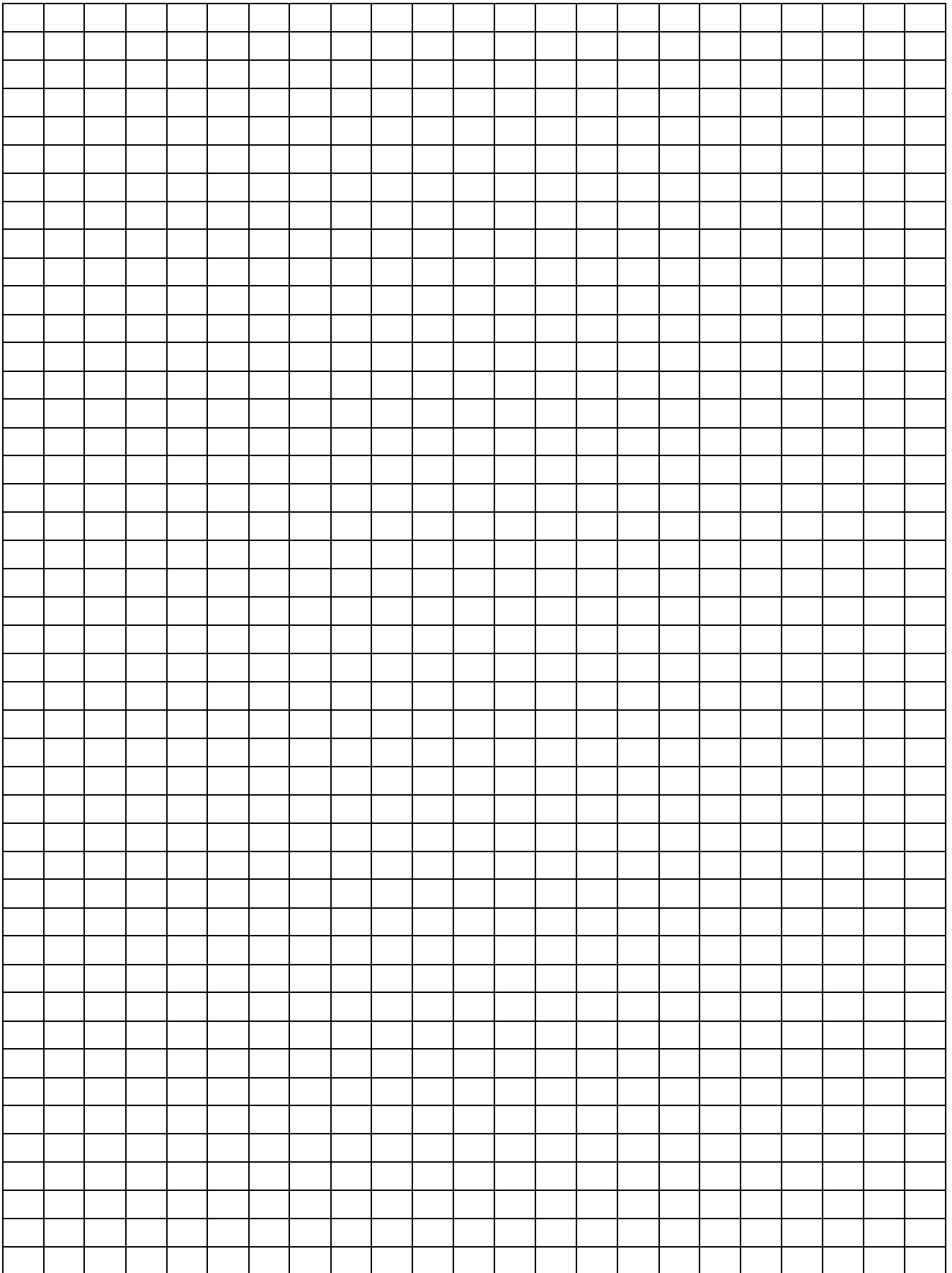

**W**

**E**

**S**





## SEED PIECE PROFILE TABLE



NAME \_\_\_\_\_

DATE \_\_\_\_\_

VARIETY \_\_\_\_\_

TIME \_\_\_\_\_

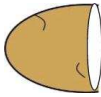
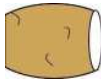
PULP TEMPERATURE \_\_\_\_\_

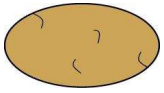
Actual Weight	1 Cut Top or Bottom Table	2" Barrel Cut Bottom Table	1 3/4" Barrel Cut Top Table	Horizontal Vertical Cut	One Drop
					
1.4 oz. & under					
1.5-2.9 oz.					
3-4 oz.					
4.1 oz. & over					

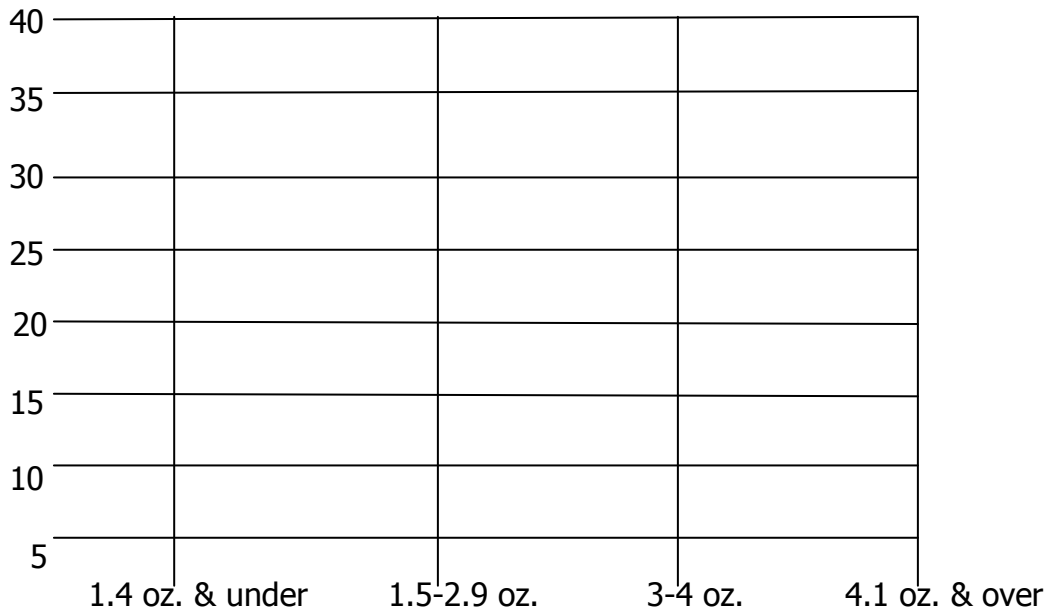

**N**

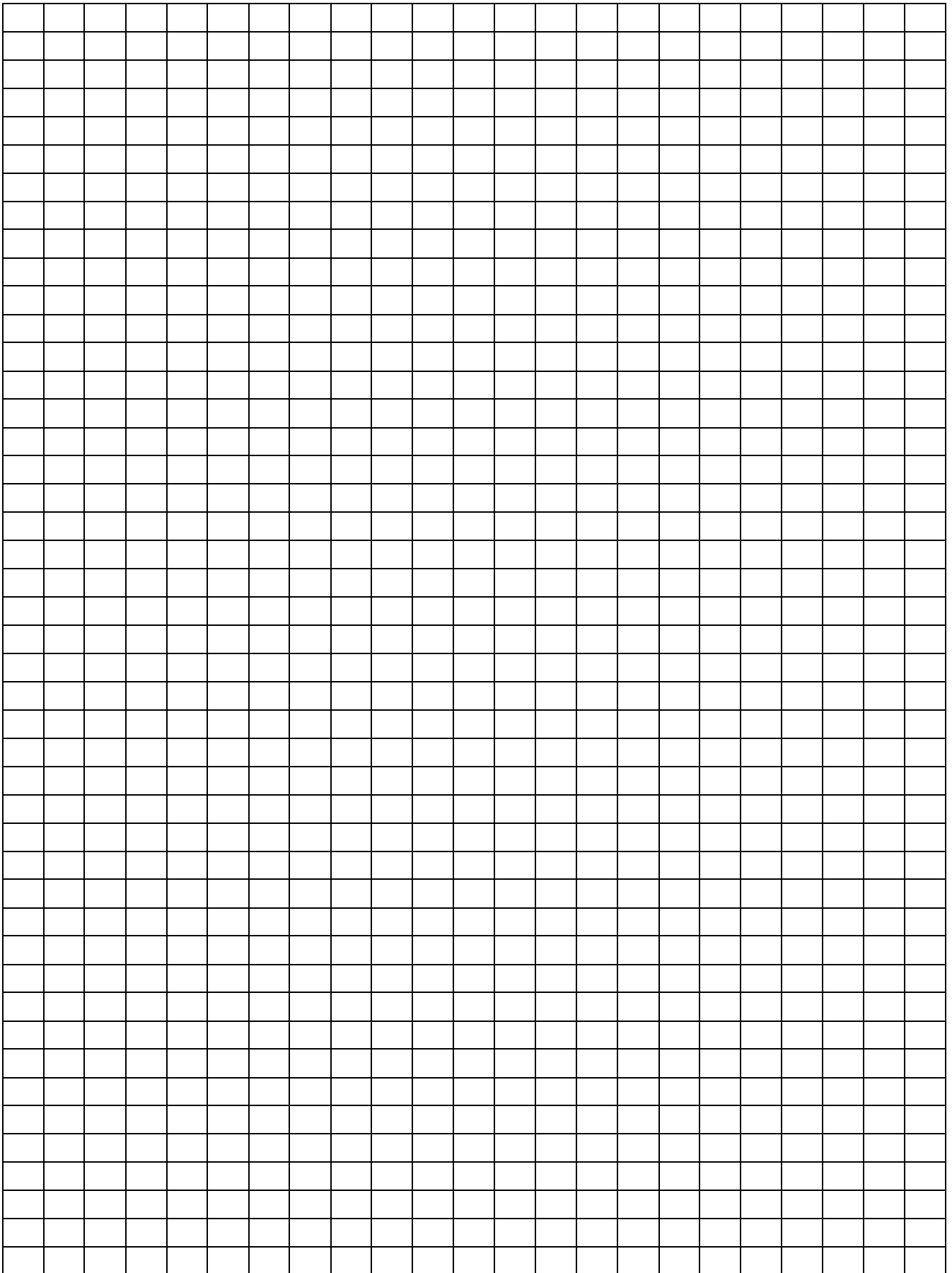

**W**

**E**

**S**



## SEED PIECE PROFILE TABLE



NAME \_\_\_\_\_

DATE \_\_\_\_\_

VARIETY \_\_\_\_\_

TIME \_\_\_\_\_

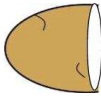
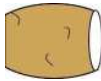
PULP TEMPERATURE \_\_\_\_\_

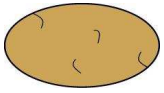
Actual Weight	1 Cut Top or Bottom Table	2" Barrel Cut Bottom Table	1 3/4" Barrel Cut Top Table	Horizontal Vertical Cut	One Drop
					
<b>1.4 oz. &amp; under</b>					
<b>1.5-2.9 oz.</b>					
<b>3-4 oz.</b>					
<b>4.1 oz. &amp; over</b>					

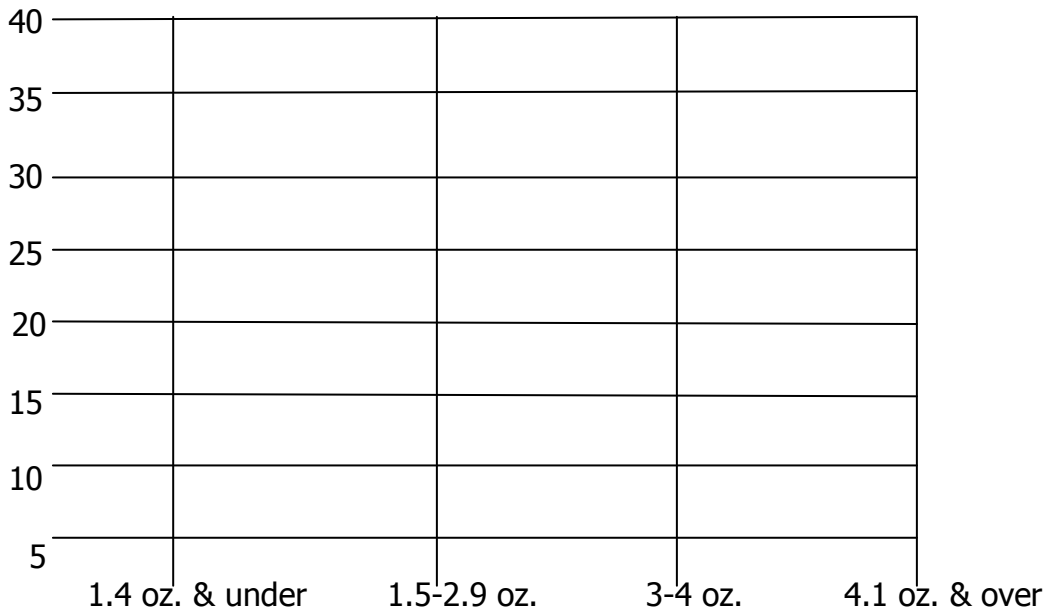

**N**

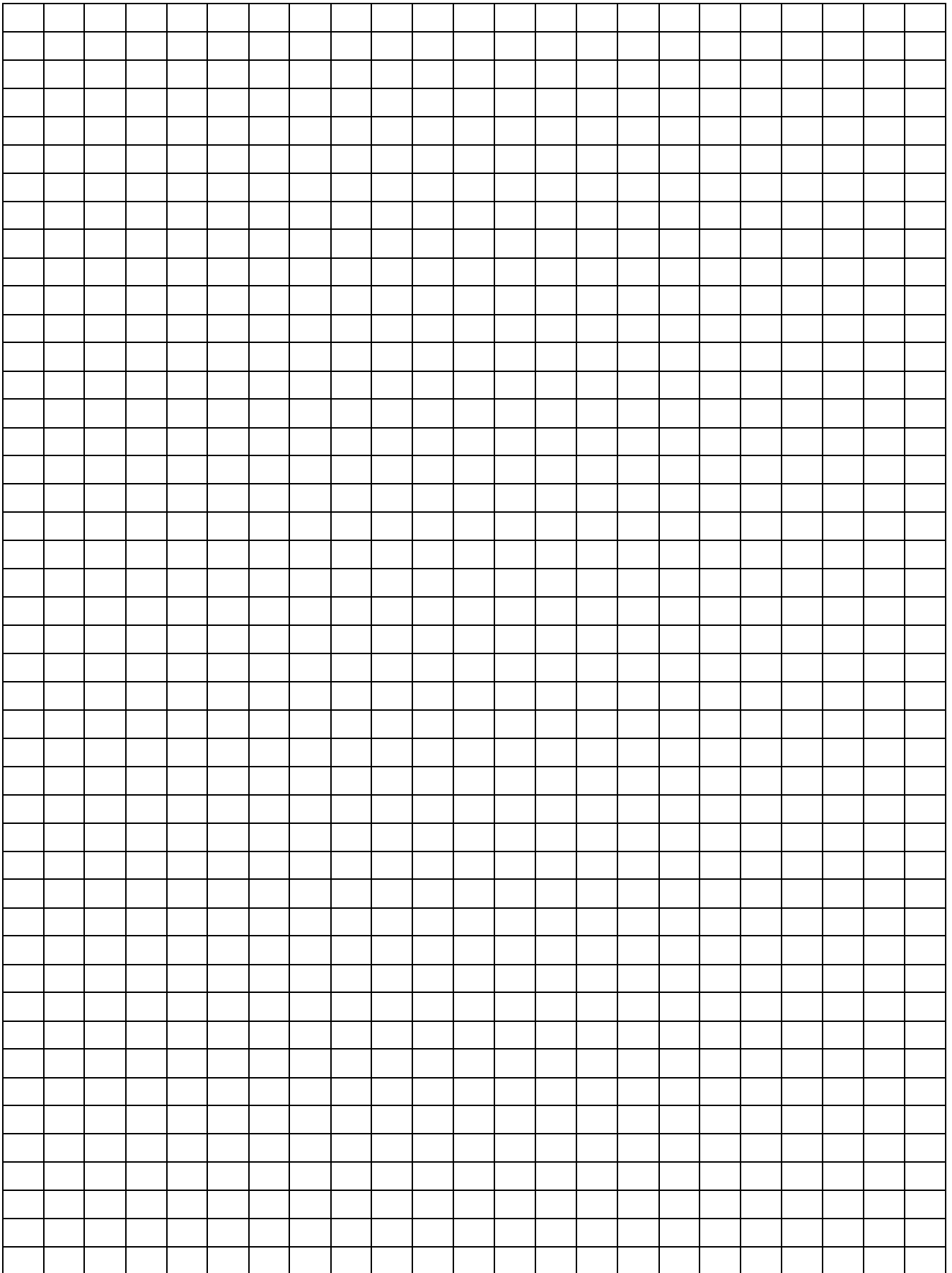

**W**

**E**

**S**



## SEED PIECE PROFILE TABLE



NAME \_\_\_\_\_

DATE \_\_\_\_\_

VARIETY \_\_\_\_\_

TIME \_\_\_\_\_

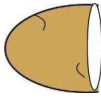
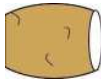
PULP TEMPERATURE \_\_\_\_\_

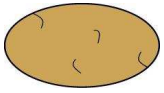
Actual Weight	1 Cut Top or Bottom Table	2" Barrel Cut Bottom Table	1 3/4" Barrel Cut Top Table	Horizontal Vertical Cut	One Drop
					
1.4 oz. & under					
1.5-2.9 oz.					
3-4 oz.					
4.1 oz. & over					

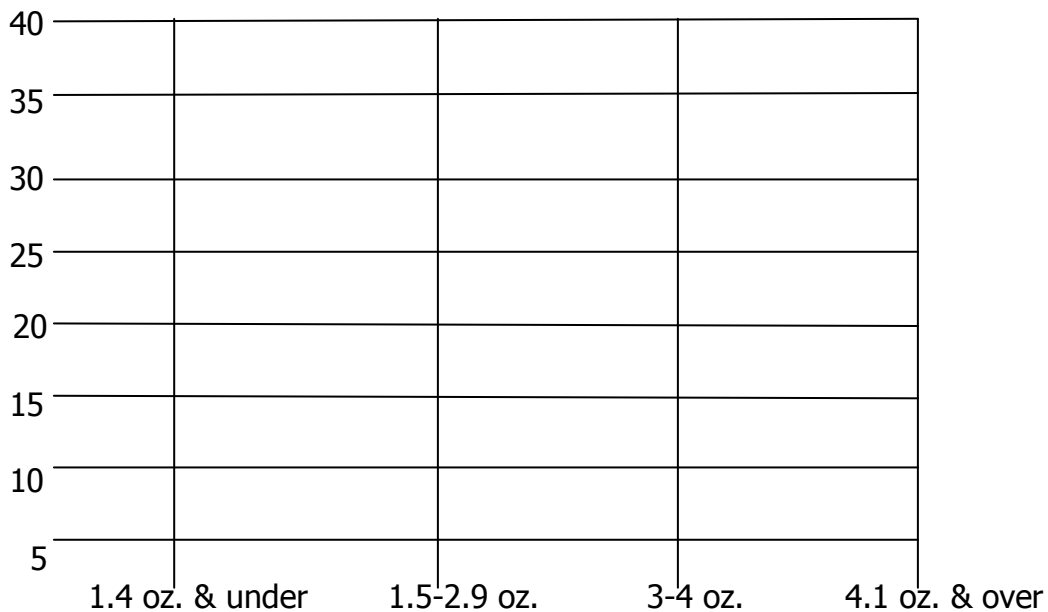

**N**

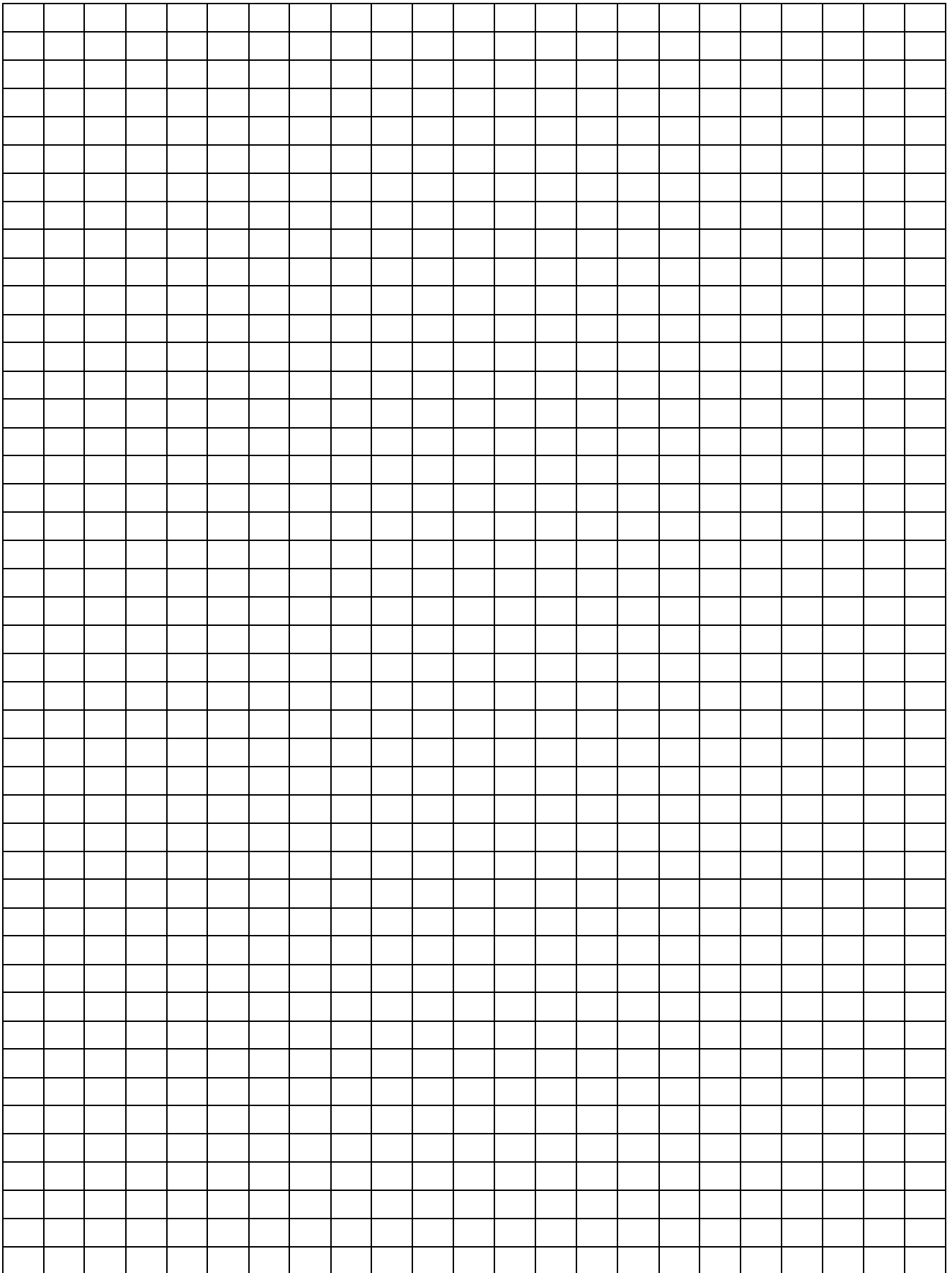

**W**

**E**

**S**



## SEED PIECE PROFILE TABLE



NAME \_\_\_\_\_

DATE \_\_\_\_\_

VARIETY \_\_\_\_\_

TIME \_\_\_\_\_

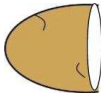
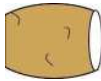
PULP TEMPERATURE \_\_\_\_\_

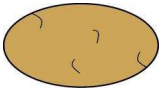
Actual Weight	1 Cut Top or Bottom Table	2" Barrel Cut Bottom Table	1 3/4" Barrel Cut Top Table	Horizontal Vertical Cut	One Drop
					
<b>1.4 oz. &amp; under</b>					
<b>1.5-2.9 oz.</b>					
<b>3-4 oz.</b>					
<b>4.1 oz. &amp; over</b>					

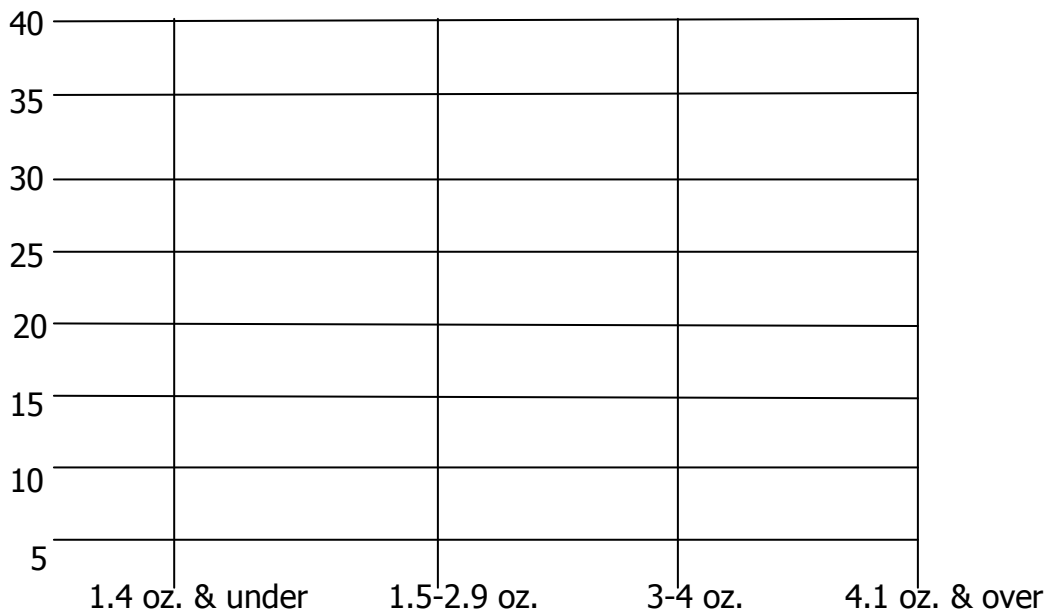

**N**

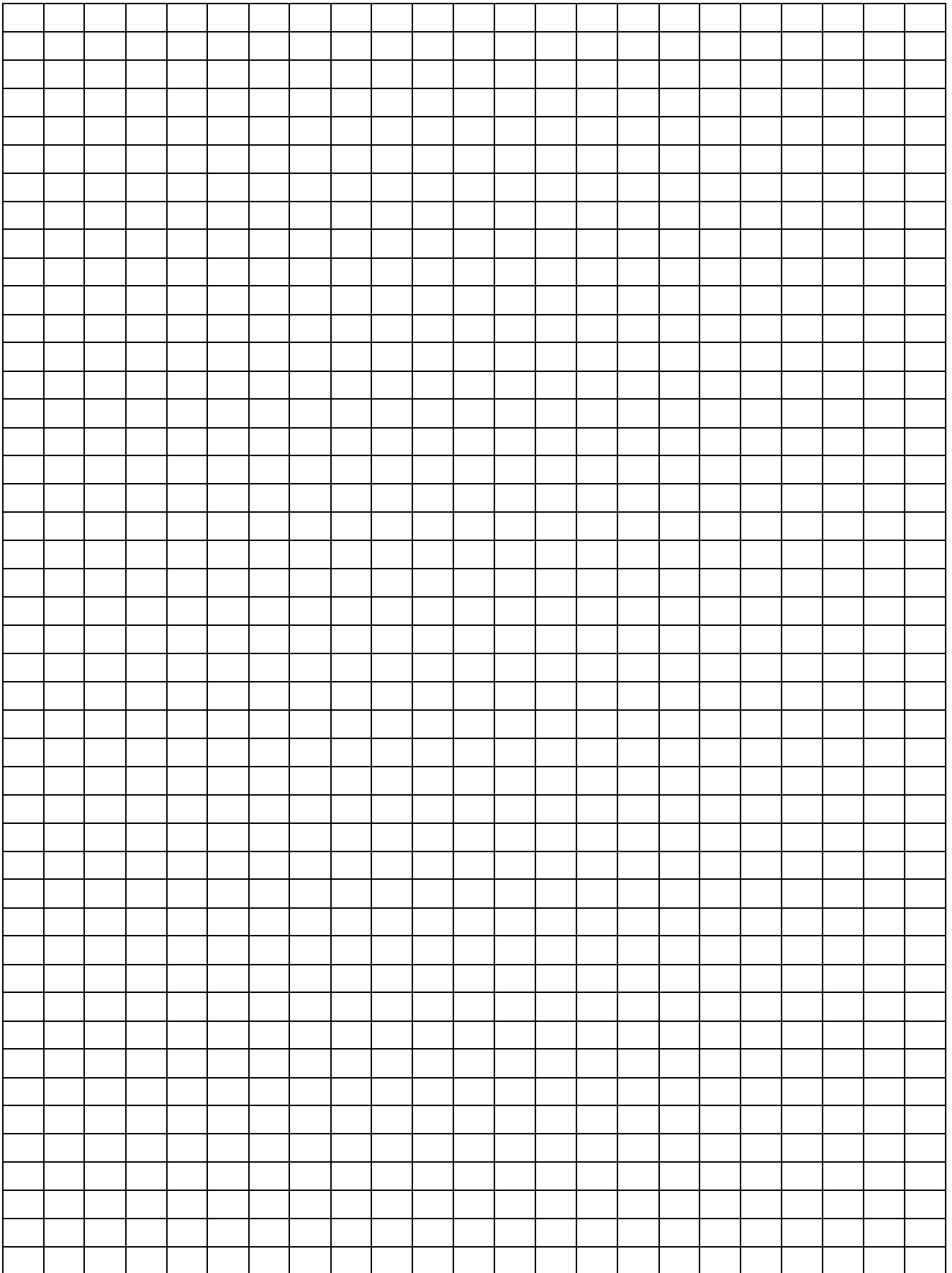

**W**

**E**

**S**





## SEED PIECE PROFILE TABLE



NAME \_\_\_\_\_

DATE \_\_\_\_\_

VARIETY \_\_\_\_\_

TIME \_\_\_\_\_

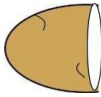
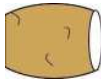
PULP TEMPERATURE \_\_\_\_\_

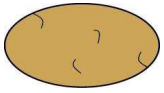
Actual Weight	1 Cut Top or Bottom Table	2" Barrel Cut Bottom Table	1 3/4" Barrel Cut Top Table	Horizontal Vertical Cut	One Drop
					
1.4 oz. & under					
1.5-2.9 oz.					
3-4 oz.					
4.1 oz. & over					

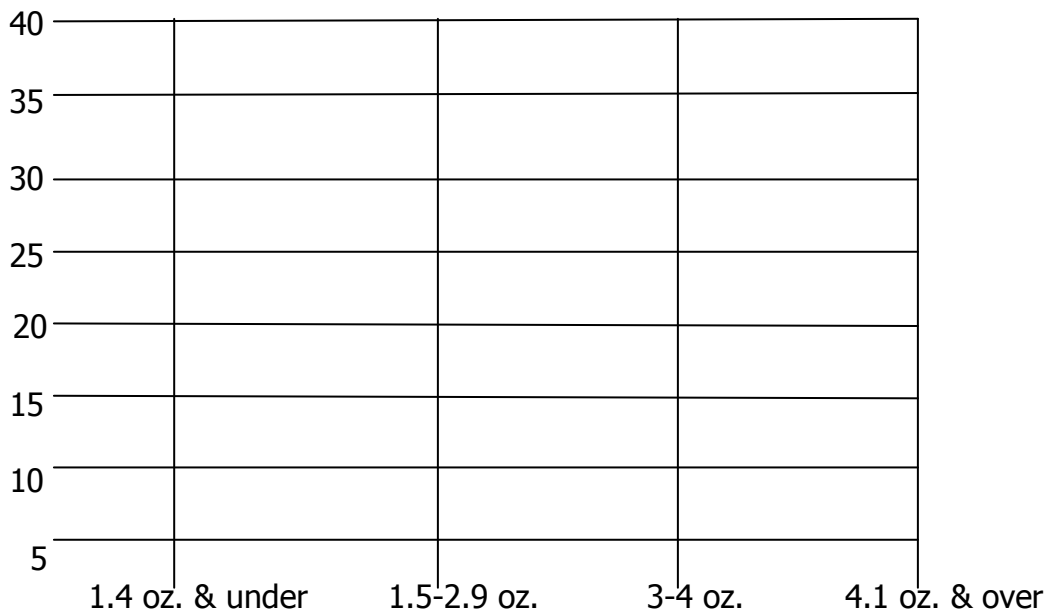

**N**

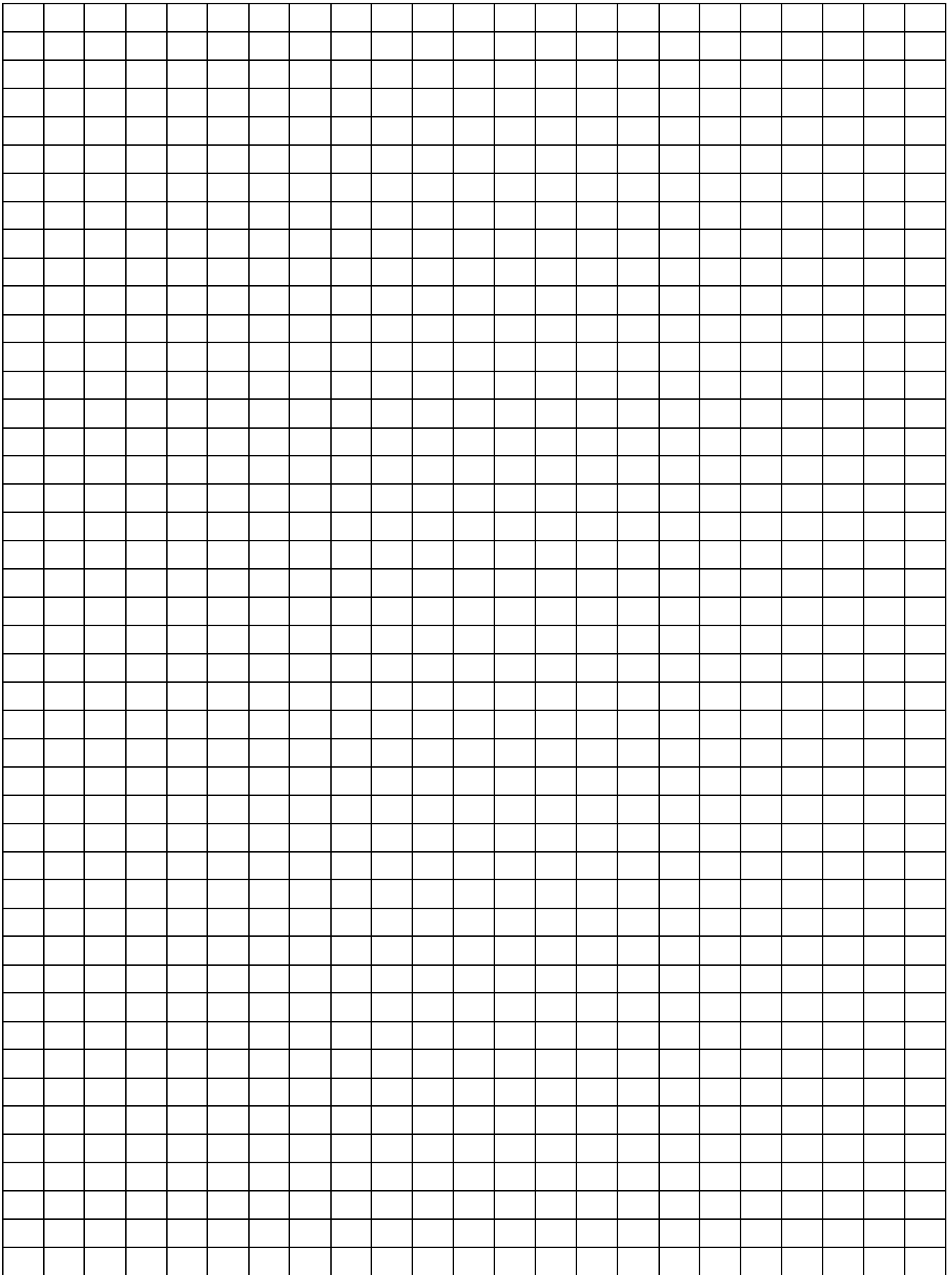

**W**

**E**

**S**



## SEED PIECE PROFILE TABLE





NAME \_\_\_\_\_

DATE \_\_\_\_\_

VARIETY \_\_\_\_\_

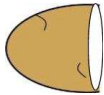
TIME \_\_\_\_\_

PULP TEMPERATURE \_\_\_\_\_

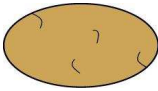
Actual Weight	1 Cut Top or Bottom Table	2" Barrel Cut Bottom Table	1 3/4" Barrel Cut Top Table	Horizontal Vertical Cut	One Drop
					
1.4 oz. & under					
1.5-2.9 oz.					
3-4 oz.					
4.1 oz. & over					

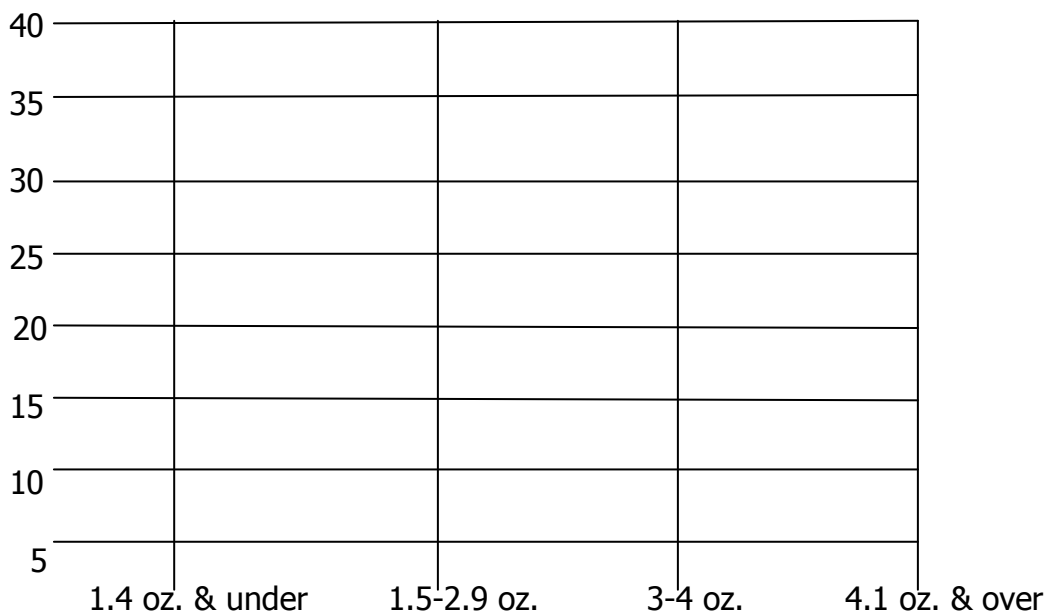

**N**

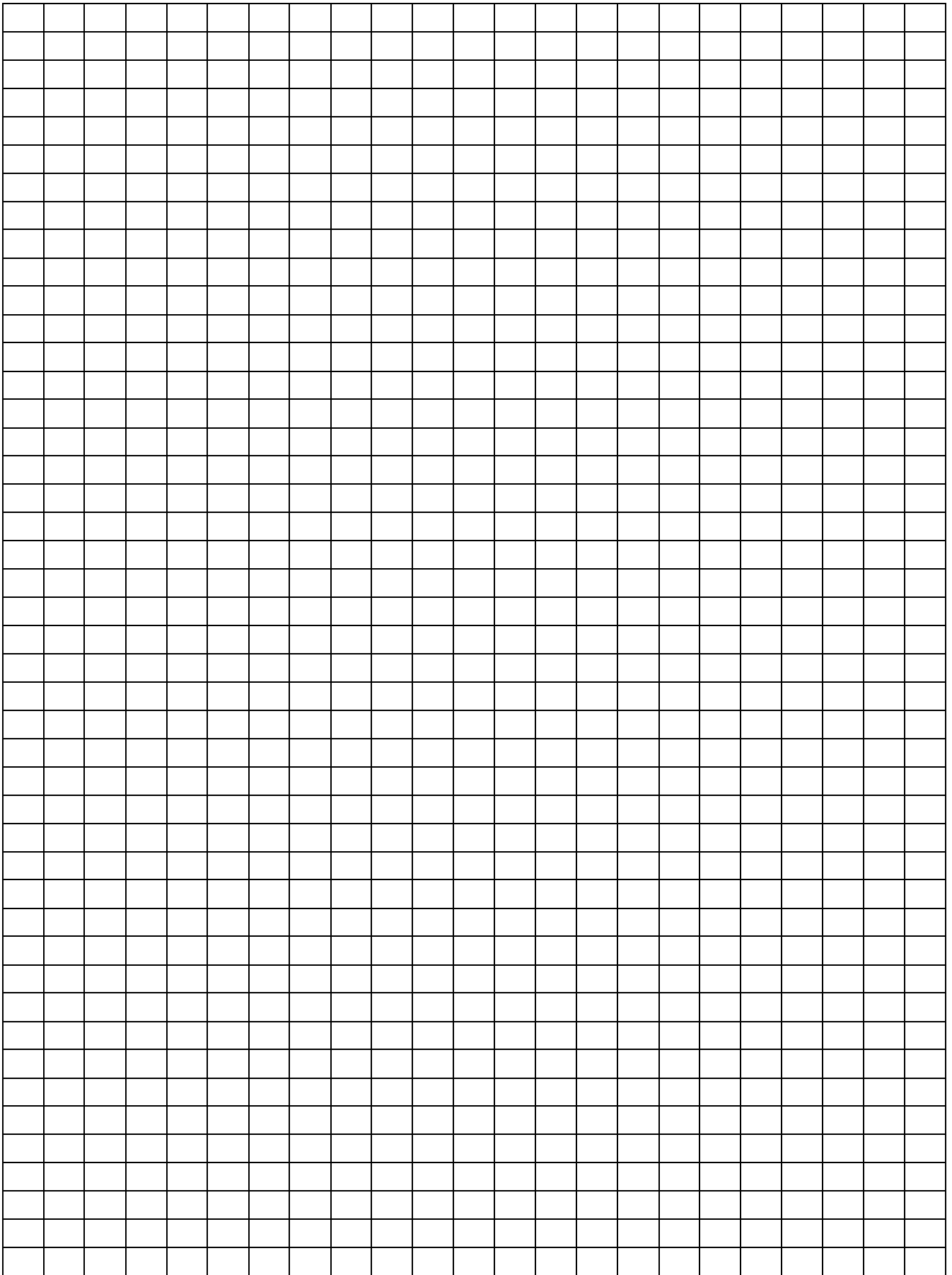

**W**

**E**

**S**



## SEED PIECE PROFILE TABLE





NAME \_\_\_\_\_

DATE \_\_\_\_\_

VARIETY \_\_\_\_\_

TIME \_\_\_\_\_

PULP TEMPERATURE \_\_\_\_\_

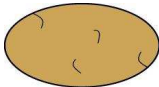
Actual Weight	1 Cut Top or Bottom Table	2" Barrel Cut Bottom Table	1 3/4" Barrel Cut Top Table	Horizontal Vertical Cut	One Drop
					
1.4 oz. & under					
1.5-2.9 oz.					
3-4 oz.					
4.1 oz. & over					

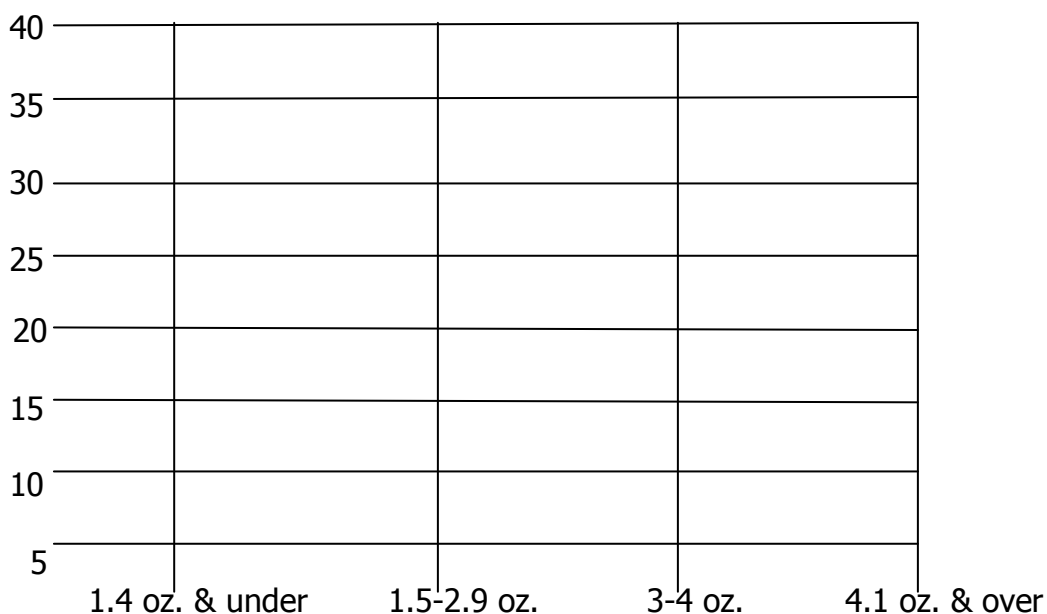

**N**

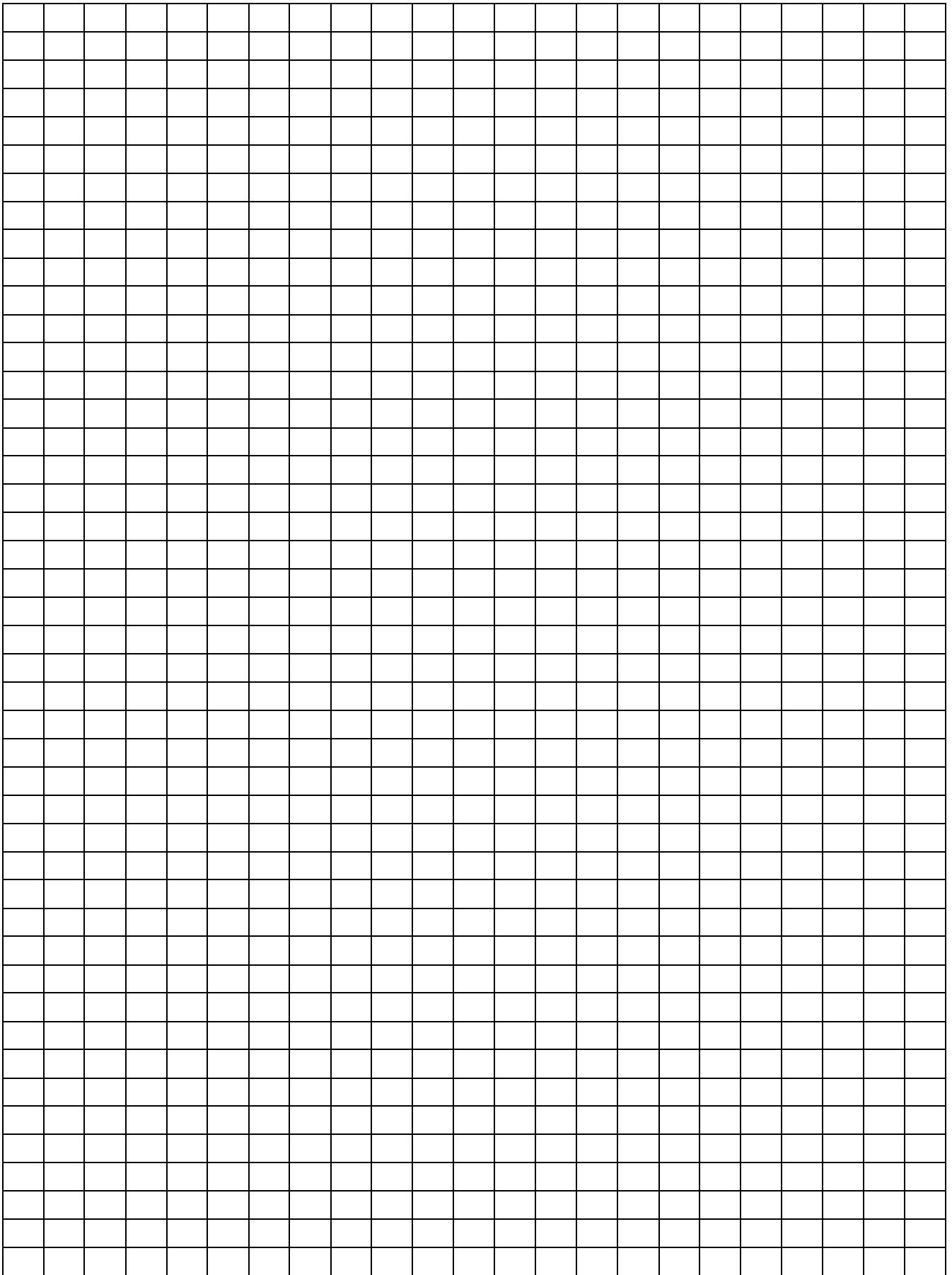

**W**

**E**

**S**



## SEED PIECE PROFILE TABLE



NAME \_\_\_\_\_

DATE \_\_\_\_\_

VARIETY \_\_\_\_\_

TIME \_\_\_\_\_

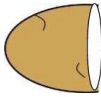
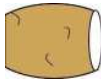
PULP TEMPERATURE \_\_\_\_\_

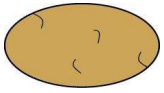
Actual Weight	1 Cut Top or Bottom Table	2" Barrel Cut Bottom Table	1 3/4" Barrel Cut Top Table	Horizontal Vertical Cut	One Drop
					
1.4 oz. & under					
1.5-2.9 oz.					
3-4 oz.					
4.1 oz. & over					

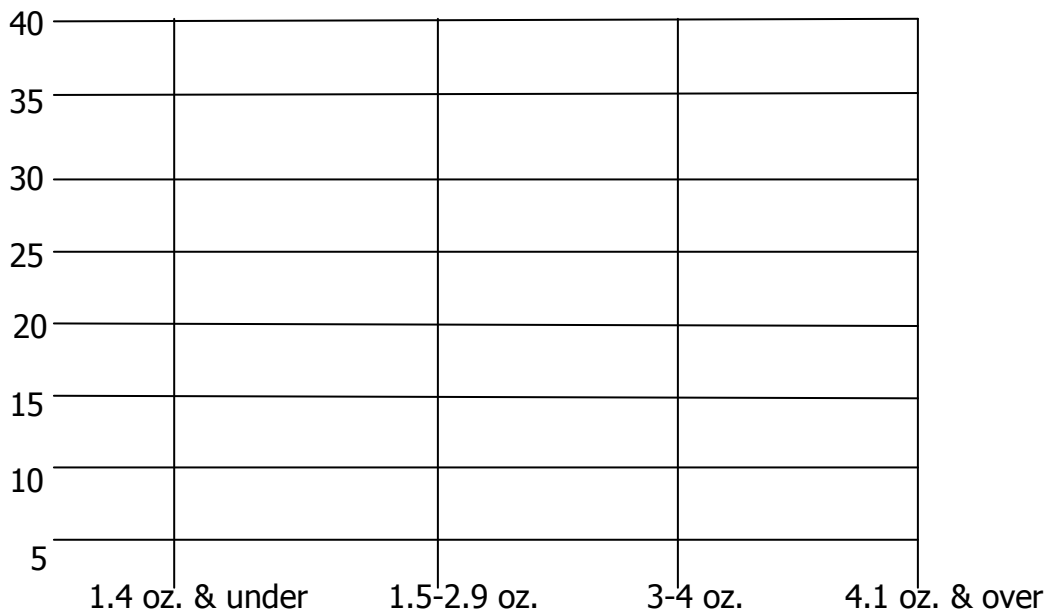

**N**

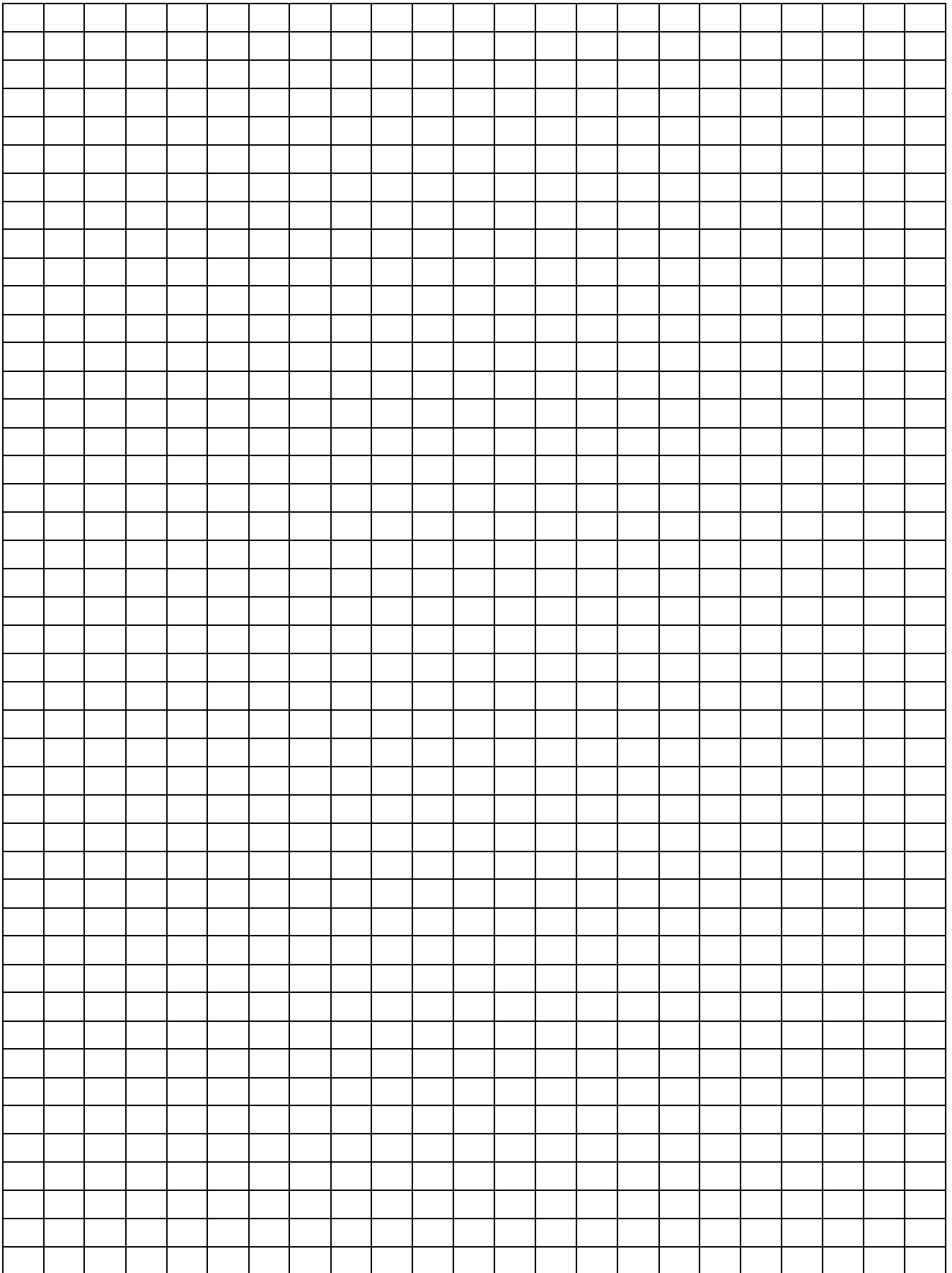

**W**

**E**

**S**





## SEED PIECE PROFILE TABLE



NAME \_\_\_\_\_

DATE \_\_\_\_\_

VARIETY \_\_\_\_\_

TIME \_\_\_\_\_

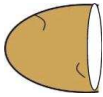
PULP TEMPERATURE \_\_\_\_\_

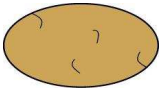
Actual Weight	1 Cut Top or Bottom Table	2" Barrel Cut Bottom Table	1 3/4" Barrel Cut Top Table	Horizontal Vertical Cut	One Drop
					
1.4 oz. & under					
1.5-2.9 oz.					
3-4 oz.					
4.1 oz. & over					

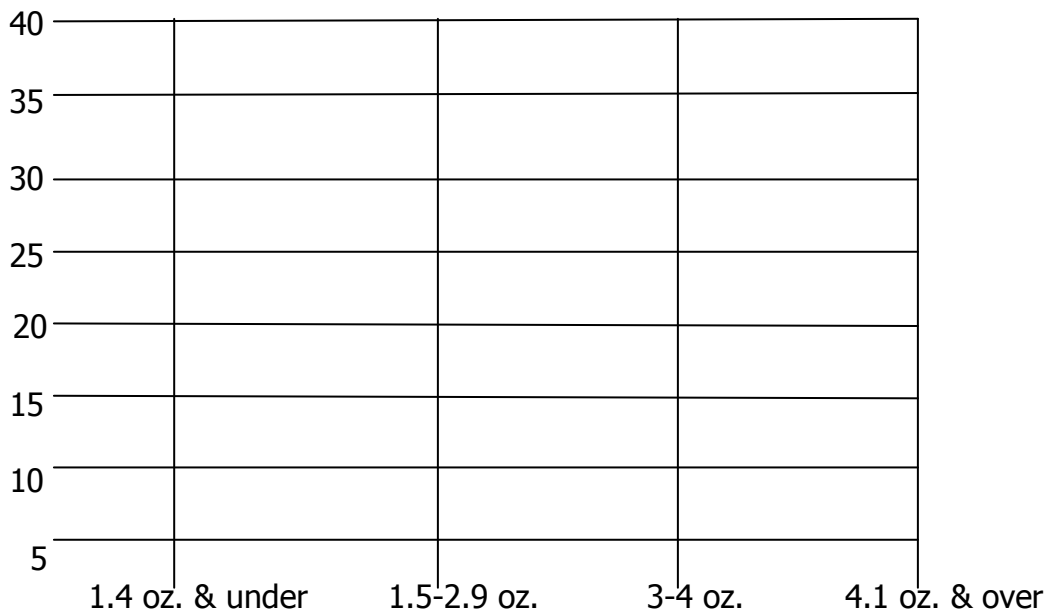

**N**

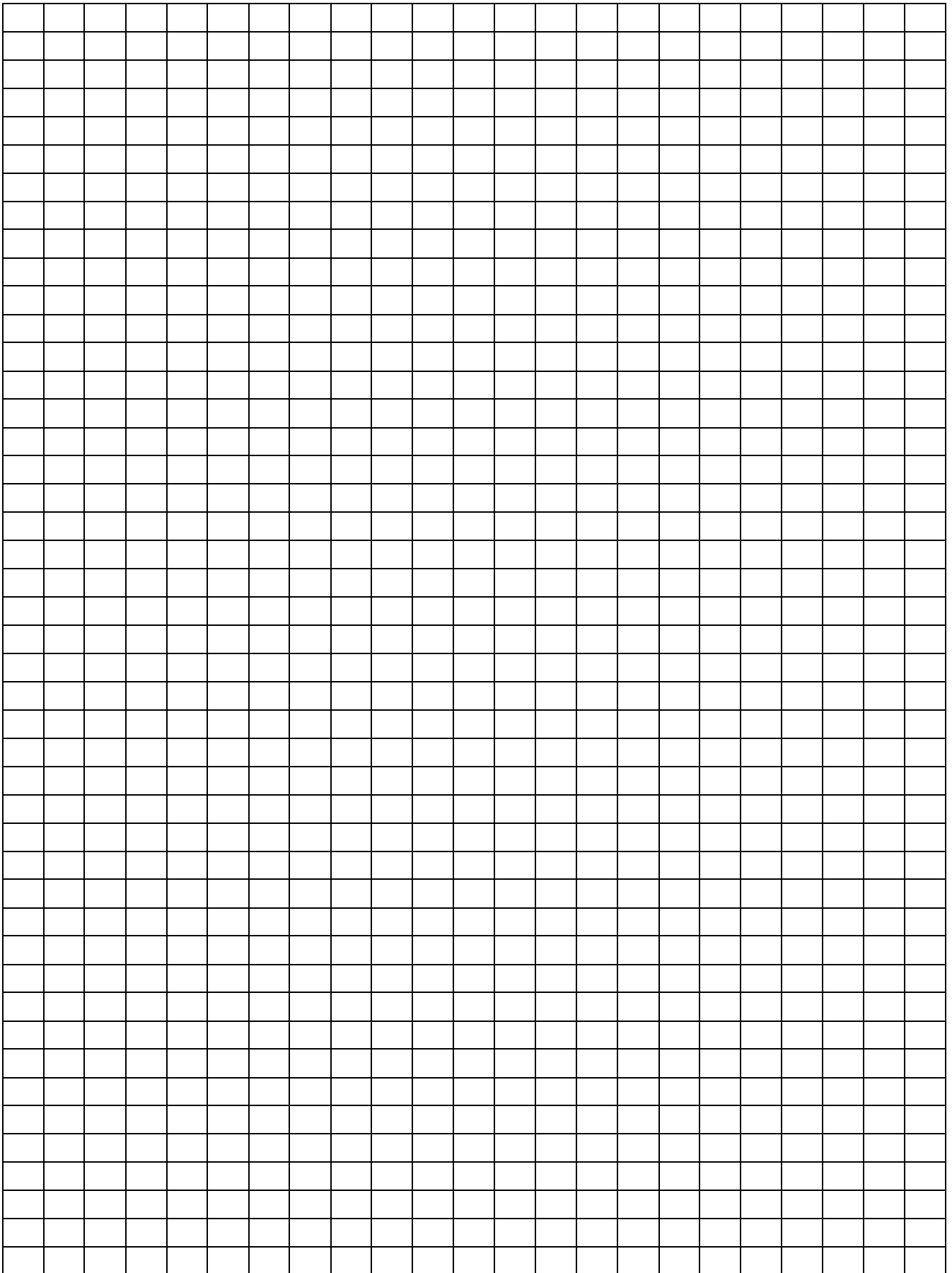

**W**

**E**

**S**



## SEED PIECE PROFILE TABLE



NAME \_\_\_\_\_

DATE \_\_\_\_\_

VARIETY \_\_\_\_\_

TIME \_\_\_\_\_

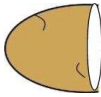
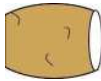
PULP TEMPERATURE \_\_\_\_\_

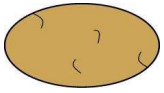
Actual Weight	1 Cut Top or Bottom Table	2" Barrel Cut Bottom Table	1 3/4" Barrel Cut Top Table	Horizontal Vertical Cut	One Drop
					
<b>1.4 oz. &amp; under</b>					
<b>1.5-2.9 oz.</b>					
<b>3-4 oz.</b>					
<b>4.1 oz. &amp; over</b>					

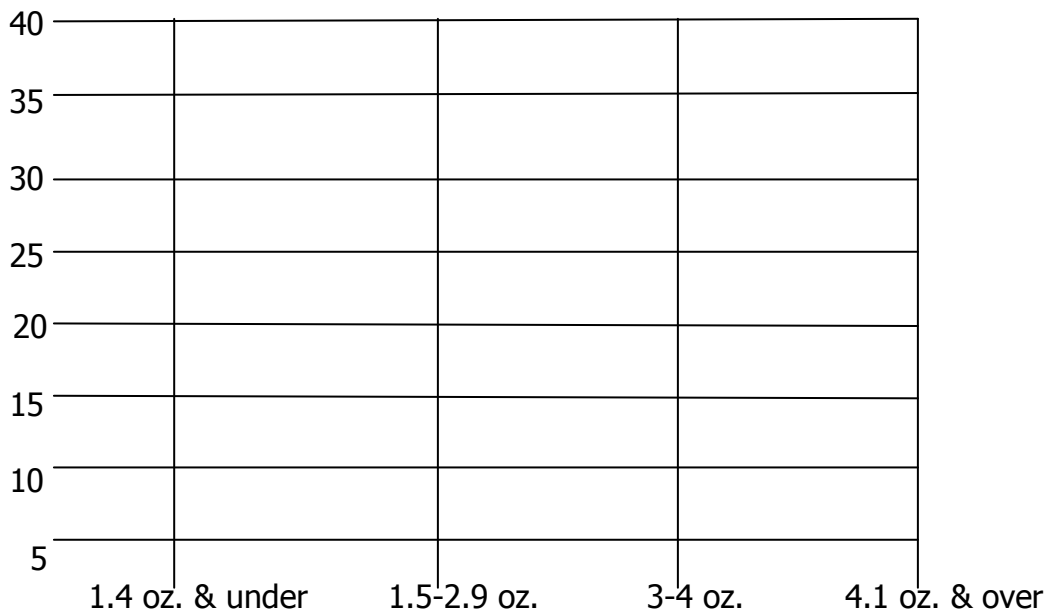

**N**

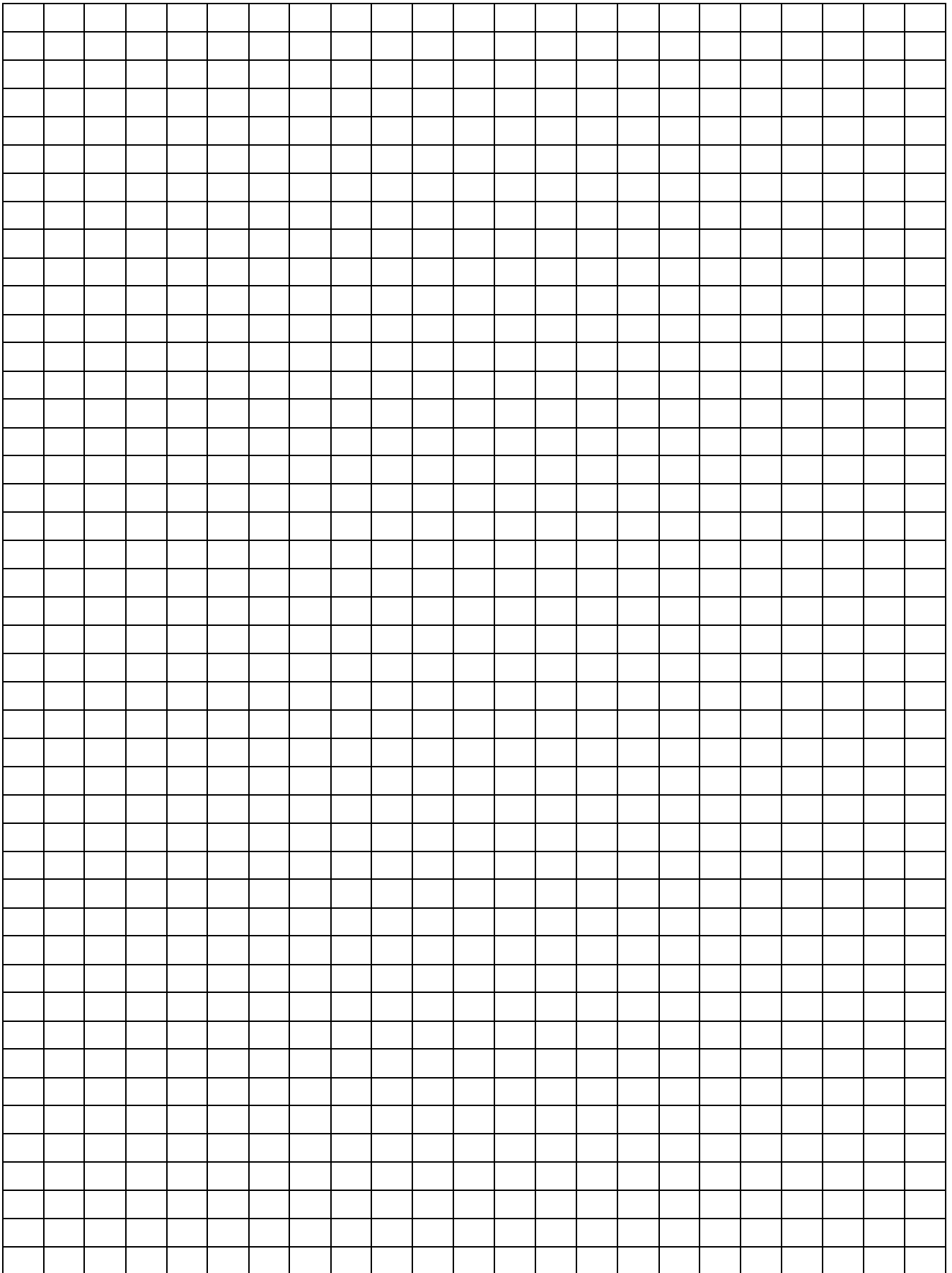

**W**

**E**

**S**



## SEED PIECE PROFILE TABLE



NAME \_\_\_\_\_

DATE \_\_\_\_\_

VARIETY \_\_\_\_\_

TIME \_\_\_\_\_

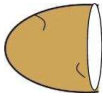
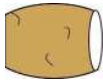
PULP TEMPERATURE \_\_\_\_\_

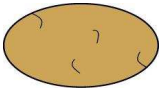
Actual Weight	1 Cut Top or Bottom Table	2" Barrel Cut Bottom Table	1 3/4" Barrel Cut Top Table	Horizontal Vertical Cut	One Drop
					
<b>1.4 oz. &amp; under</b>					
<b>1.5-2.9 oz.</b>					
<b>3-4 oz.</b>					
<b>4.1 oz. &amp; over</b>					

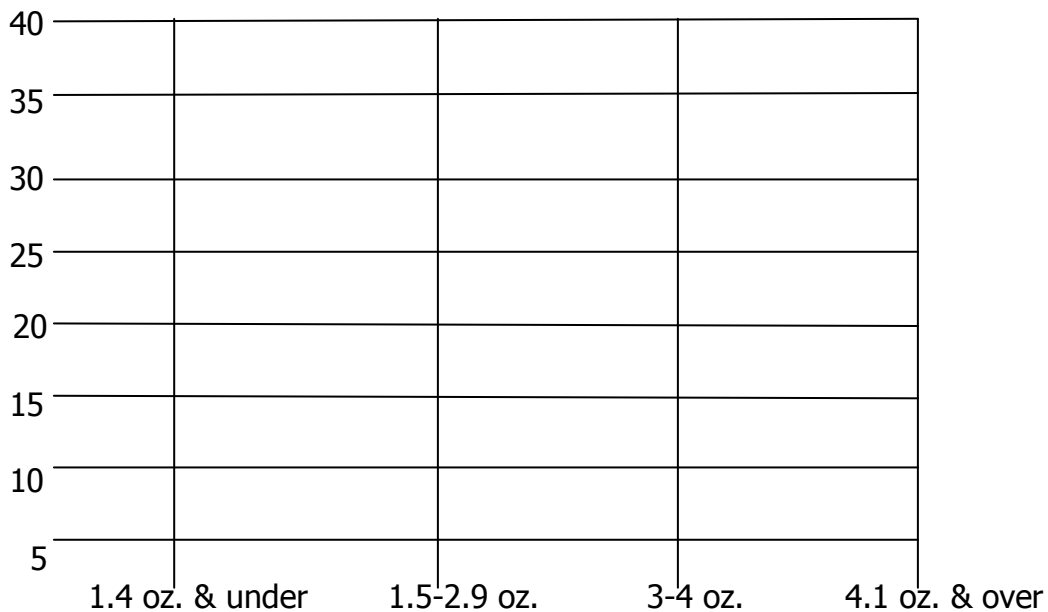

**N**

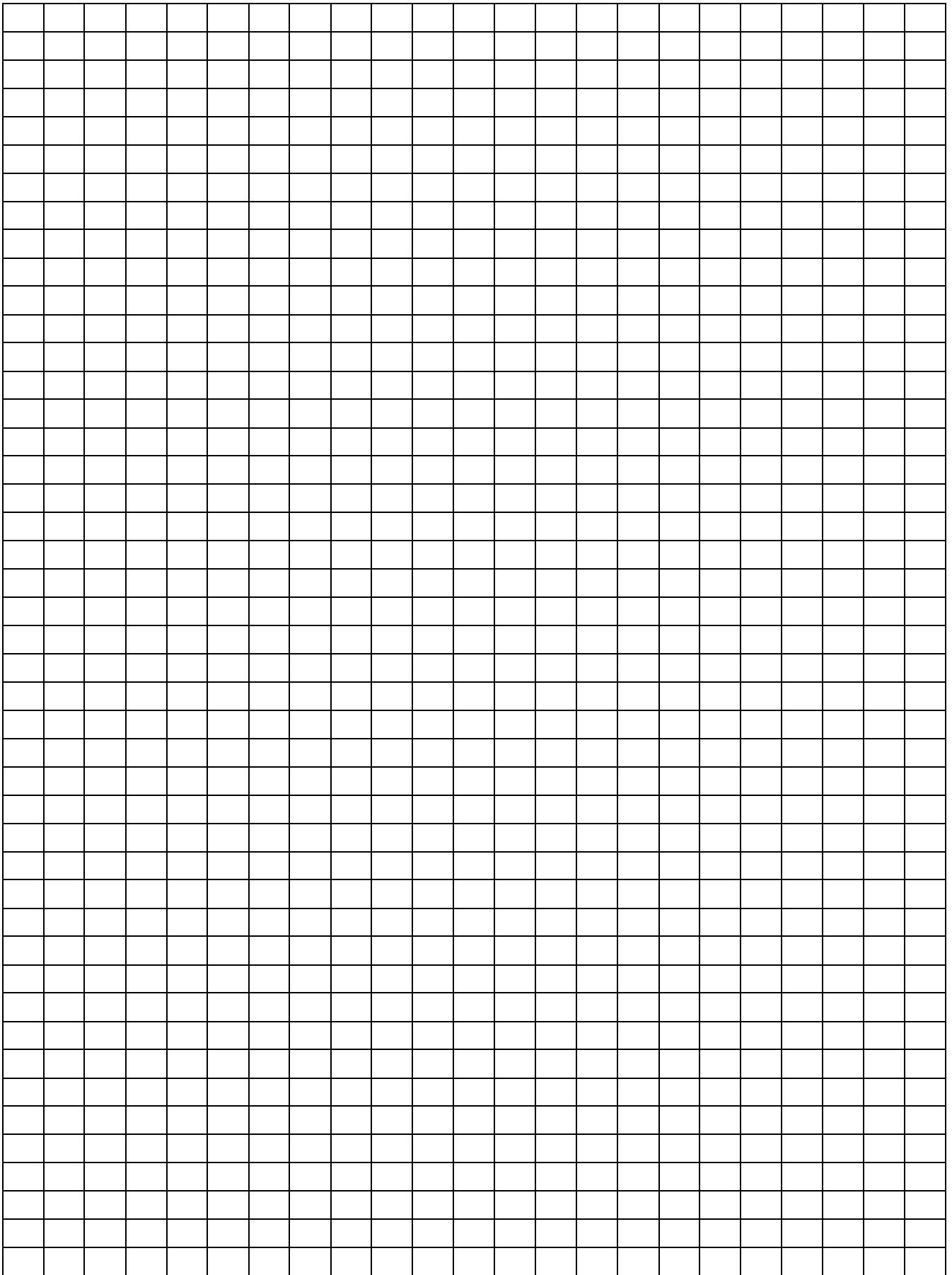

**W**

**E**

**S**